



# U 164

## DVB-C/T/T2 to IP Streamer



Operating Manual

## Contents

General information.....	page 03
Important! .....	page 04
Guarantee conditions .....	page 05
Disposal.....	page 05
Performance description .....	page 06
Device description.....	page 07
Connecting and installing the module .....	page 09
Quick start – starting operation of the U 164.....	page 12
“Status” menu.....	page 22
“Main” menu .....	page 26
“Test generator” menu.....	page 29
“Channels” menu.....	page 30
“Ch 1.X - Ch 2.X” menu .....	page 31
“CAM Mux” menu .....	page 33
“CAM 1 - CAM 4” menu .....	page 34
“IP TX” menu.....	page 37
“IP TX.1 - IP TX 8” menu.....	page 38
“TX Mux” menu.....	page 39
“User settings” menu .....	page 40
“SSL settings” menu .....	page 42
“TS analyzer” menu.....	page 44
“Licensing” menu.....	page 45
“Update/config” menu.....	page 46
“System log” menu .....	page 49
“Alarm severities” menu .....	page 51
“Active alarms” menu .....	page 52
“Statistics” menu.....	page 53
“Network” menu .....	page 55
“Devices” menu .....	page 56
Troubleshooting.....	page 57
Maintenance and repair.....	page 57
Servicing.....	page 57
Technical data .....	page 58

## General information

**NOTE:** This operating manual was created to provide the most important instructions for operating the U 164 module. We expressly recommend reading this manual before installing or operating the devices.

The ASTRO company confirms the information in this manual to be correct at the time of printing, but it reserves the right to make changes, without prior notice, to the specifications, the operation of the device and the operating manual.

### Symbols used in these instructions

Pictograms are visual symbols with specific meanings. You will encounter the following pictograms in this installation and operating manual:



Warning about situations in which electrical voltage and non-observance of the instructions in this manual pose a risk of fatal injuries.



Warning about various dangers to health, the environment and material.



Recycling symbol: indicates components or packaging materials which can be recycled (cardboard, inserts, plastic film and bags). Used batteries must be disposed of at approved recycling points. Batteries must be completely discharged before being disposed of.



This symbol indicates components which must not be disposed of with household rubbish.

### Copyright information

Parts of the software used with this product originate from third-party vendors and were developed under a variety of licensing conditions. Detailed information on the licences can be found on the device's web user interface. If you select the menu item "Licensing" on the web browser interface of the device, you will find a link to a page with detailed information.

You can obtain the source code for licence-free parts of the software upon request and against payment of a processing fee.

Please contact us at:

kontakt@astro-strobel.de  
 ASTRO Strobel Kommunikationssysteme  
 Olefant 1-3  
 D-51427 Bergisch Gladbach (Germany)  
 Tel.: (+49) 2204 405-0

All other parts of the software used with this product are subject to the copyright owned by ASTRO Strobel GmbH.

**Important!**

Before using the device, read the operating manual carefully and store it for future reference.

**ATTENTION:** *This device is Class A equipment. It may cause radio interference in living areas. In this case, the operator may be obliged to take appropriate precautions!*

**General safety**

**ATTENTION:** *Disconnect both power plugs before opening the device!*

To avoid any potential risks to the greatest extent possible, it is very important that you observe the safety instructions in the operating manual for the U100-230 / U-100-48 base unit.

**Assembly instructions**

**IMPORTANT:** *The outputs of the signal converter must not be operated without connecting a combining network or terminating impedance!*

The module U 164 may only be operated in the base units U 100-230 and U 100-48 made by ASTRO.

Observe the assembly instructions in the operating manual for the U 100-230 / U 100-48 base unit.

## Warranty conditions

The general terms and conditions of ASTRO Strobel GmbH apply. You will find these in the current catalogue or on the Internet under “[www.astro-kom.de](http://www.astro-kom.de)”.

## Disposal



All of our packaging material (cardboard boxes, inserts, plastic film and bags) is completely recyclable. Electronic devices must not be disposed of with household waste, but rather – according to DIRECTIVE 2002/96/EC OF THE EUROPEAN PARLIAMENT AND OF THE COUNCIL from January 27, 2003, on waste electrical and electronic equipment – must be properly disposed of. When it is no longer in use, please bring the device for disposal to one of the public collection points for this purpose.

ASTRO Strobel is a member of the Elektro system solution for the disposal of packaging materials. Our contract number is 80395.

## Performance description

The U 164 uses an input socket for reception of up to four DVB-C, DVB-T or DVB-T2 streams. The output signals from the four DVB-C, DVB-T or DVB-T2 receivers can each be routed to one of four CAM modules in total for decryption. The output signals from the four CAM modules can each be routed via a multiplexer to one of the eight IP transmitters, or be fed back to one of the other CAM modules.

Optionally, the output signals from the DVB-C/T/T2 receiver can also be routed directly to one of the IP transmitters.

The two Ethernet data ports in the U 164 can then be used to output up to 8 IP video data streams.

To use the devices properly, read the following safety and operating instructions attentively.

The U 164 plug-in module features the following performance characteristics:

- Conversion of up to 4 DVB-C, DVB-T or DVB-T2 input signals into 8 IP gigabit multicast groups
- 24 streams per height unit possible
- Easy configuration using web browser interface



The delivery is comprised of the following parts:

- U 164 DVB-C/DVB-T/DVB-T2 in IP streamer, including a display module and backplane
- Operating manual

The U 164 plug-in module and the U 100 base unit feature a CE marking. This confirms that the products conform to the relevant EC directives and adhere to the requirements specified therein.

Figure 1, top:  
U 164, installed in the U 100 base unit  
(fitted with three plug-in modules)



Figure 1, middle:  
U 144, front panel  
[1] Screw for the front panel  
[2] Display for management IP addresses,  
data IP addresses, status messages, etc.  
[3] Status display  
[4] Control and data knob, menu switch



Figure 1, bottom:  
U 194, front panel after removal  
[5] Release button, CI-slot 1  
[6] Release button, CI-slot 2  
[7] Release button, CI-slot 3  
[8] Release button, CI-slot 4

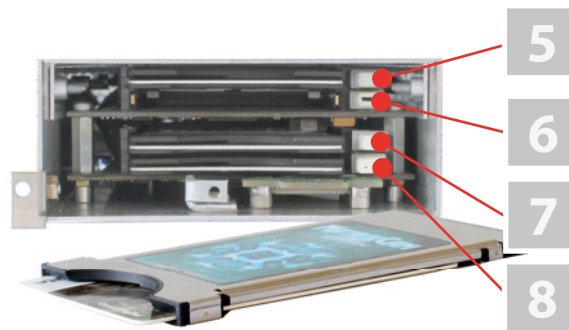
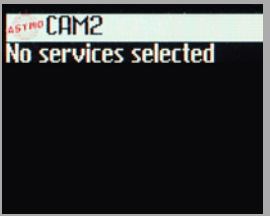
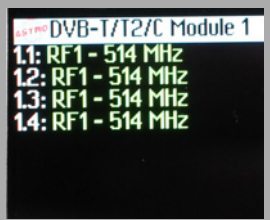
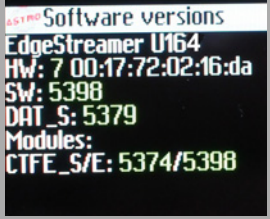
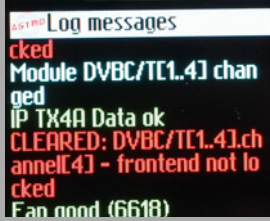

Figure 1: U 164



**NOTE:** Turning the data knob [4] (fig. 2, above) allows you to navigate through the individual menu items in the U 168 display. Press the data knob to switch on the display.

The ASTRO logo will be the first display to appear following activation.

Turning the data knob clockwise allows to you access the individual displays:

- Log messages: The last messages entered in the log book are displayed.
  
- Interface settings: IP addresses of the network interface.
  
- Software versions: The version of the plug-in module software currently installed is displayed.
  
- Active alarms: The current error messages are displayed.
  
- DVB-T/T2/C module 1: The status of the four channels set is displayed.
  
- CAM modules 1 - 4 The respective reception channel forwarded to the CAM module is displayed.

The different text colours refer to:

- Red: Error (the corresponding display in the web interface log book is: "error")
- Yellow: Warning (the corresponding display in the web interface log book is: "warning")
- Purple: Critical error (the corresponding display in the web interface log book is: "critical / alert / emergency")
- Light blue: Info (the corresponding display in the web interface log book is: "info")
- Light green: Notice (the corresponding display in the web interface log book is: "notice")



## Connecting and installing the module

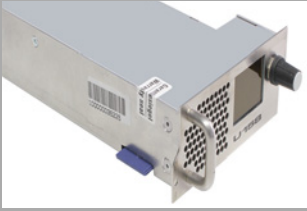

**NOTE:** The instructions for the base unit U 100 include a description of how to prepare the base unit for installation.

Observe that you need to insert an SD memory card into the module prior to installation in the base unit (see figure at left).

### Coding and installing the backplane

A backplane is included with every U 1xx signal converter. This is used to establish a mechanical connection between the signal converter and the base unit. Both the mains HF connections and the network connections are connected to this backplane. There is usually a temperature-controlled fan for cooling the signal converter on the backplane. This can be replaced while the device is operating.

To ensure the position of the backplane, and therefore the position of the respective signal converter in the U 100 base unit, is correct, you must plug a corresponding jumper into the circuit board on the backplane. Proceed as described in the following.

- [1] Left slot
- [2] Middle slot
- [3] Right slot

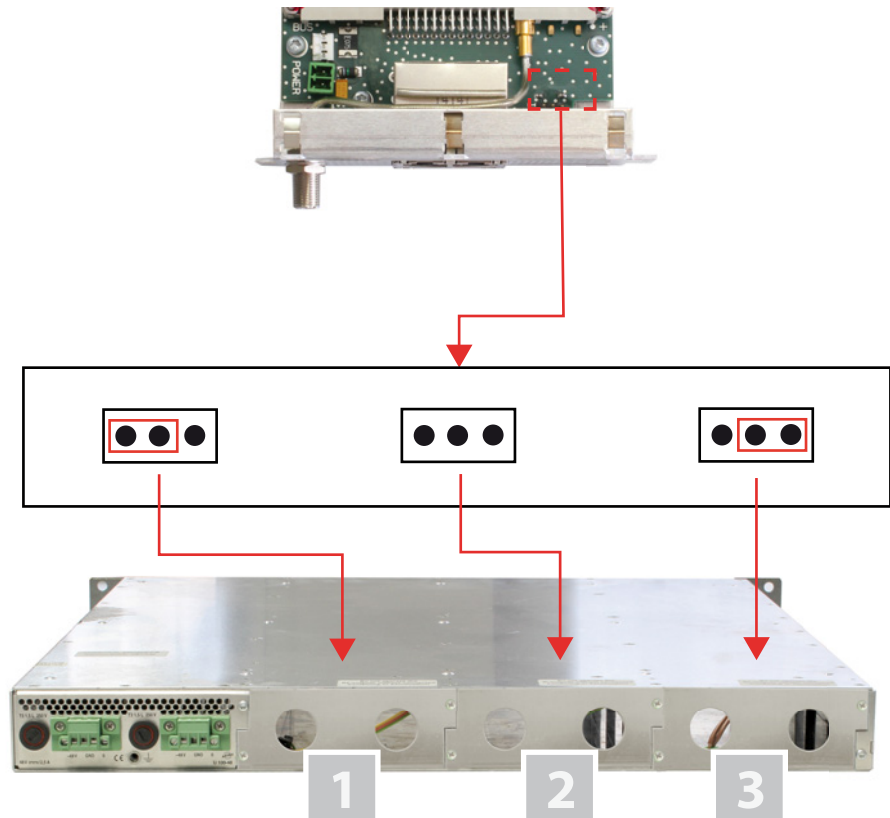

Figure 2: Coding the backplane by plugging in the jumper

To prepare the backplane for installation, proceed as follows:

Plug the jumper into the installation position provided in accordance with figure 3 (page 8).

**NOTE:** A jumper which has not been correctly plugged into the corresponding installation position will result in incorrect LED displays on the front of the U 100 base unit (see section "Device description"). Furthermore, the correct position cannot be displayed on the web browser user interface.

You can now install the backplane in the base unit. To do so, proceed as follows:

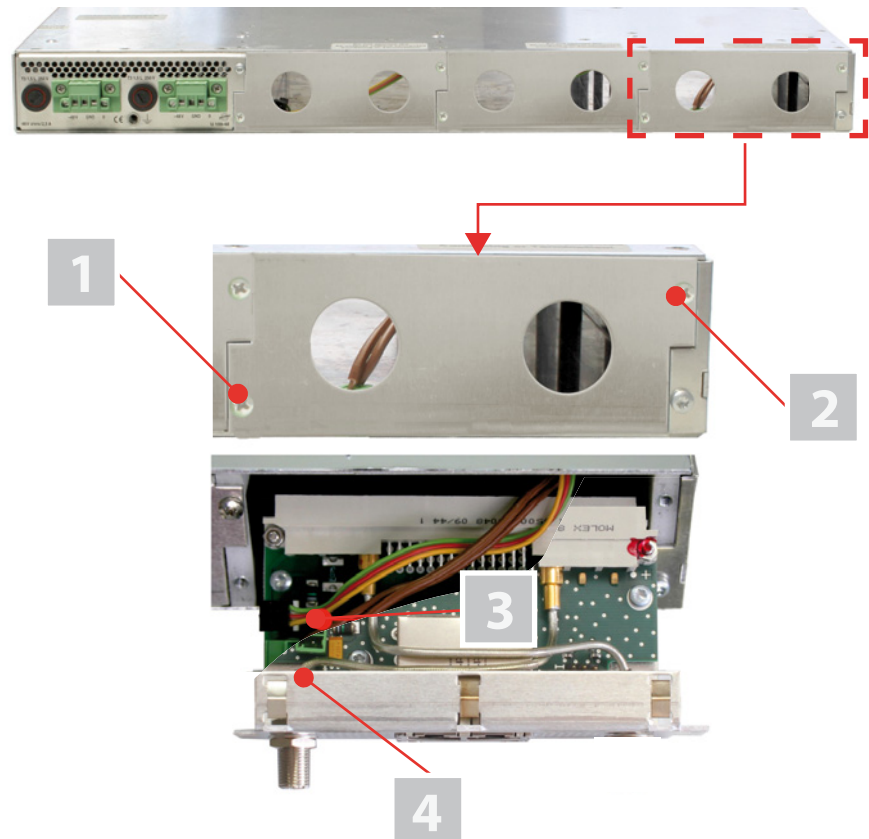

- [1, 2] Phillips-head screws
- [3] Cable for signal supply
- [4] Cable for power supply

Figure 3: Installing the backplane in the base unit

#### TASK

1. When the U 100 base unit is in its delivery state, the three installation slots for the backplanes are covered by dummy plates (see figure 3, above). Start by removing the Phillips-head screws [1] and [2] from the dummy plate at the required installation position (left, middle or right) and remove the dummy plate.
2. You can now see the two connection cables for the selected slot (power supply and signal cable). Connect the cables to the backplane as shown in figure 3 (above).
3. Now carefully insert the backplane into the slot of the U 100. Make sure the cables are not jammed. You can push the backplane into the housing by applying light pressure.

#### RESULT:

The backplane is now connected and installed. Once installed, it should correspond to the figure at the left.

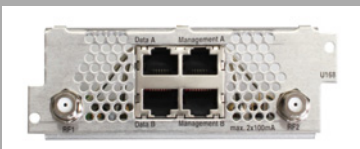

## Inserting CI cards

**NOTE:** CI cards can also be inserted and removed while the module is operating.

Before you can insert the CI cards, you must undo the screw connection [1] on the front panel of the U 194 (see fig. 5, below) and remove the front panel together with the display. The four CI slots and the release buttons for ejecting the CI modules are visible.

Start by pushing each CI card into a CI module, and then push each module into one of the four CI slots in the U 194.

To remove a CI module, press the corresponding eject button and remove the module.

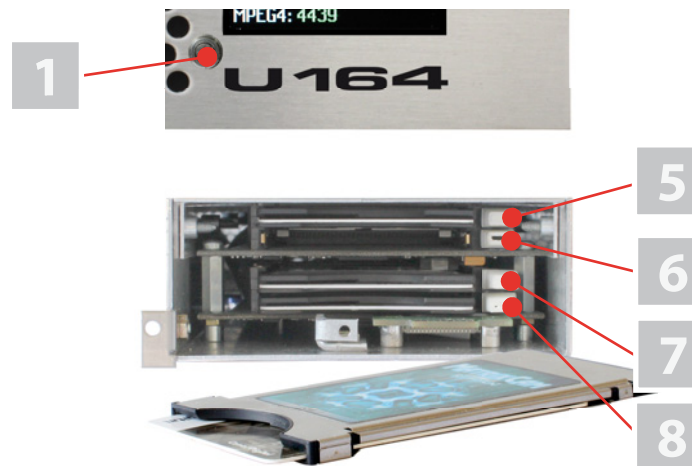

[1] Screw for the front panel

[5] Release button, CI-slot 3

[6] Release button, CI-slot 4

[7] Release button, CI-slot 3

[8] Release button, CI-slot 4

Figure 4: CI slots

## Quick start - starting operation of the U 164

### Connecting the U 164 to a PC or laptop

To be able to configure the U 164, you now need to connect the network sockets (Management A or Management B) on the backplane of the device (see figure at left) to your PC or laptop using a network cable.

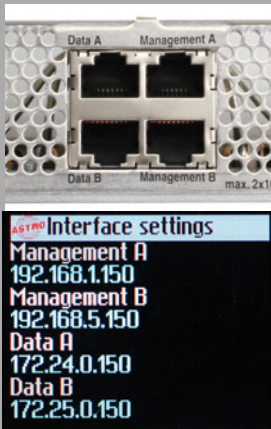

Once you have connected the base unit to the power supply, the U 164 will switch on automatically. Once it has booted (approx. 90 seconds), the ASTRO logo initially appears in the display. Turn the knob to the right of the display clockwise until the menu item "Interface settings" is displayed. The two management IP addresses (Management A and Management B) for the device now appear in the upper lines.

Make a note of the address of the management connection which you are using for your PC or laptop to ensure you can enter this in the address line of your web browser later on.

***NOTE:** Please note that your PC or laptop must be in the same sub-network as the U 164! The sub-network mask of the U 164 is set to 255.255.255.0 upon delivery. The PC or laptop which is connected must therefore be assigned an IP address 192.168.1.x.*

You can now start the configuration using the web browser user interface.

### General information on the structure of the web browser interface

The configuration interface is divided into the following sub-areas:

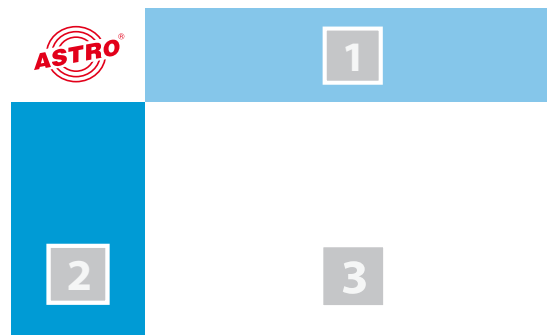

Figure 5: Structure of the web browser interface

- Status line (header) [1]:** displays general information on the module.  
SW: Software status  
HW: Hardware version  
Up: Runtime since the system was booted  
Time: Date and time  
Name, location, contact: corresponds to the settings which were made in the "User settings" configuration area
- Navigation menu [2]:** displays the individual configuration areas which can be selected by clicking the mouse. A detailed description of these areas can be found on the following pages of this chapter.
- Content area [3]:** The respective configuration form – depending on the menu item selected – is displayed here.

***NOTE:** The browser display is not updated automatically. Use the corresponding button in the menu of your browser to update the display.*

### Logging in

To log in, enter the IP address of the U 164, which appears in the device display, in the address line of the browser. The menu page “Status” will then appear. Select the item “Log in” from the navigation menu at the left. The input mask for the log in should then appear (see figure 6, below). In delivery state, you must use the following log-in data:

- User name:** “user” or “admin” (input without inverted commas)
- Password:** astro

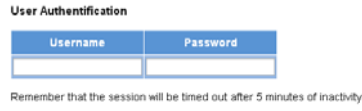

Figure 6: Log in

After logging in, the start page of the U 164 with all relevant system information will appear. The navigation menu and the log-in status display will appear at the left.

Only one user can be logged into the user interface of the U 164 at a time. The current user is displayed in the column at the left, below the menu.

The device status is indicated by a green or red circle. If a green circle is displayed, the device is operational. If the circle is red, then a fault has occurred.

A list of current errors is available under the menu item “Active alarms”.

**NOTE:** For reasons of security, you should change the access data valid upon delivery (user name and password) to prevent unauthorised access! The procedure is described in the section “Changing user data”.

### Changing the IP address

**NOTE:** If you wish to change the IP address, then the settings on the PC must be changed accordingly.

Start by changing the IP addresses for the management and the data port. To do so, click on the item “Main” in the menu at the left. You will now see the following table in the content area:

**IP Interface Settings**

Property	Management A (eth0)	Management B (eth1)	Data A (eth2)	Data B (eth3)
MAC	00:17:72:02:00:d0	00:17:72:03:00:d0	00:17:72:04:00:d0	00:17:72:05:00:d0
Active	<input checked="" type="radio"/> on <input type="radio"/> off	<input checked="" type="radio"/> on <input type="radio"/> off	<input checked="" type="radio"/> on <input type="radio"/> off	<input checked="" type="radio"/> on <input type="radio"/> off
Mode	1 Gbit/s, full duplex	1 Gbit/s, full duplex	1 Gbit/s, full duplex	1 Gbit/s, full duplex
Address	192 . 168 . 1 . 150	192 . 168 . 5 . 150	172 . 24 . 0 . 150	172 . 25 . 0 . 150
Subnet	255 . 255 . 255 . 0	255 . 255 . 255 . 0	255 . 255 . 0 . 0	255 . 255 . 0 . 0
Broadcast	192.168.1.255	192.168.5.255	172.24.255.255	172.25.255.255
Gateway	192 . 168 . 1 . 100	0 . 0 . 0 . 0	0 . 0 . 0 . 0	0 . 0 . 0 . 0

Figure 7: Changing the IP address

You can enter the IP addresses for management ports A and B as well as for data ports A and B in the “Address” line. Make sure that you activate the ports being used by activating the corresponding radio button in the line “Active”.

To save your changes, click on the “Submit” button below the last table.

More information on configuring the IP address can be found in the section “Configuring IP interfaces, IP management and base unit”.

### The signal flow in the U 164

The overview on page 11 shows the possible signal paths for the U 164. The specific signal flow can be divided into the following sub-areas:

- A DVB-C/T/T2 signal can be fed in using the F socket. The input signal to the socket (RF) is transmitted to the front end.
- Four reception channels (Ch 1.1 - 1.4 and Ch 2.1 - 2.4) can be configured for the frontends.
- The signals from the four reception channels are forwarded via a multiplexer (CAM Mux) to CAM modules 1 to 4 (the overview shows, as an example, the signal from reception channel 1 to CAM 1 and the signal from reception channel 3 to CAM 2; see the red line connecting them).
- The output signals from the four CAM modules can also be transmitted via another multiplexer (TX Mux) to IP transmitters 1 to 8 respectively (the overview shows, as an example, the signal from CAM 2 to transmitter 1, the signal from CAM 3 to transmitter 3; see the red line connecting them).  
The output signals from the four reception channels can also be transmitted directly via the multiplexer (TX Mux) – bypassing the CAM decryption – to one of the 8 IP transmitters.
- Each of the output signals from the 8 IP transmitters can be forwarded to data port A and/or data port B respectively.

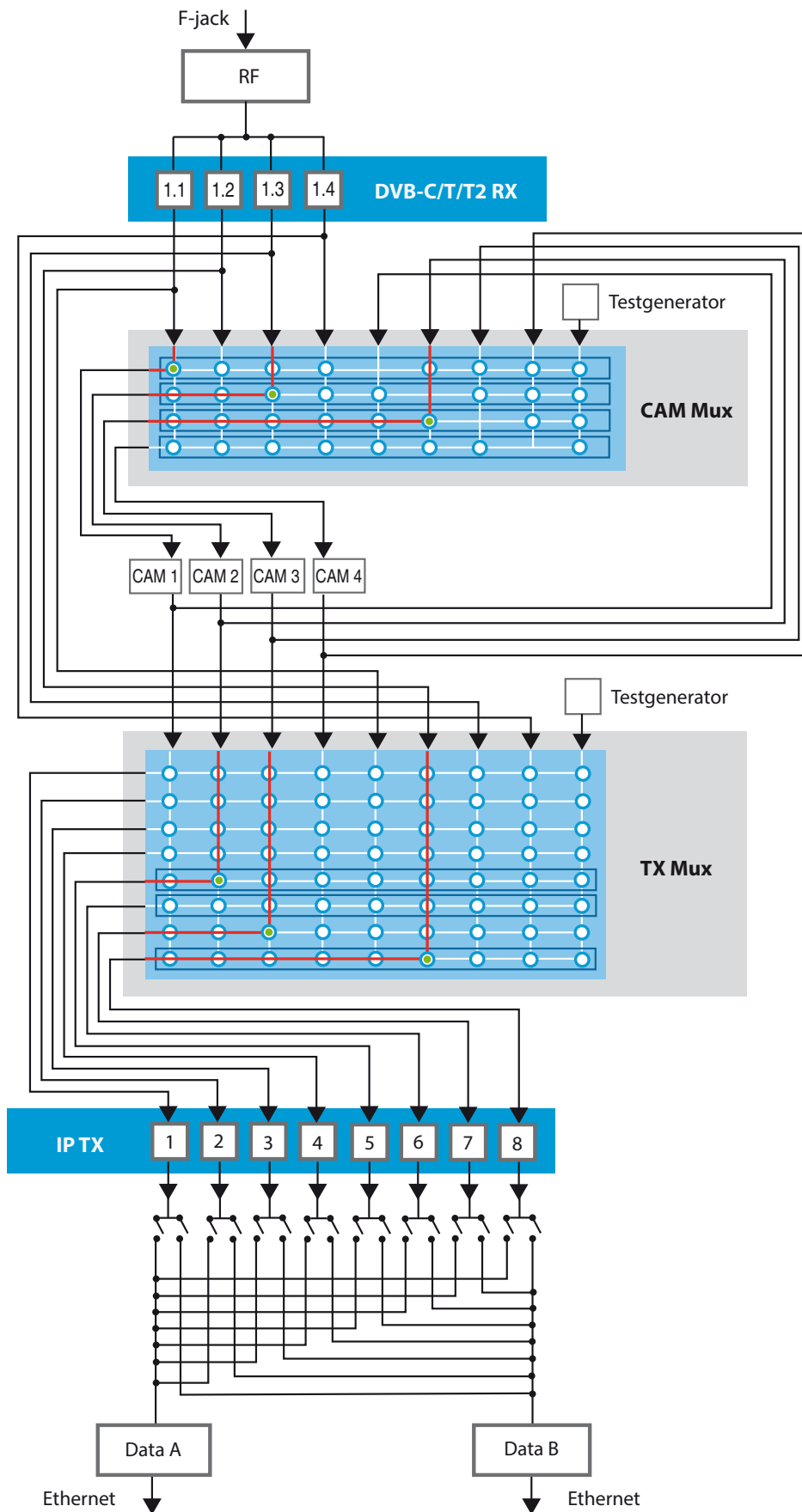

Figure 8: The signal flow in the U 164

### Configuring DVB-C/T/T2 receivers

Now start configuring a signal path in the U 164. Start by clicking on the item “Ch.1.1” in the menu in the web browser interface to have the parameters for the first reception channel displayed. You will now see the following table:

#### DVB-T/T2/C Channel Setup

Channel Parameters	
Channel Number	1.1
Channel Status	ok
RF Input	RF1
Channel enabled	<input checked="" type="radio"/> on <input type="radio"/> off
DVB System	DVB-T ▼
Center Frequency	26 (514 MHz) ▼
	manual freq.: <input type="text"/> kHz
Tune Offset	<input type="text"/> kHz
Tuning parameters	<input checked="" type="radio"/> Auto <input type="radio"/> Manual (Parameters below)

Figure 9: Selecting a reception system

Activate the radio button “on” – if this has not already been activated – in the “Channel enabled” line. This switches on the reception channel. Now select the preferred reception system (DVB-C, DVB-T or DVB-T2) from the drop-down menu in the “DVB System” line. You can enter general reception parameters first in the lines which follow.

Depending on the selection made for the reception system, you can now set specific parameters relating to the reception system in one of the following tables.

DVB-C Parameters	
Symbol Rate (Bandwidth)	< 6.96 MBaud (8 MHz) ▼

DVB-T Parameters	
Channel Bandwidth	8 MHz ▼
Guard Interval	1/8 ▼
Mode	8K ▼
Profile	HP ▼

DVB-T2 Parameters	
Channel Bandwidth	8 MHz ▼
PLP	<input type="text"/> 0

Figure 10: Setting specific reception parameters

To save your changes, click on the “Submit” button below the table.



## Checking the channel status

Now click on the item “Ch. 1.1” in the menu at the left. You will now see the following overview:

### DVB-T/T2/C Channel Setup

Channel Parameters	
Channel Number	1.1
Channel Status	ok
RF Input	RF1
Channel enabled	<input type="radio"/> on <input checked="" type="radio"/> off
DVB System	DVB-T
Center Frequency	26 (514 MHz)
	manual freq.: <input type="text"/> kHz
Tune Offset	<input type="text"/> kHz
Tuning parameters	<input checked="" type="radio"/> Auto <input type="radio"/> Manual (Parameters below)

Figure 11: Displaying channel parameters

The message “OK” should now appear in the “Channel status” line in the “DVB/T/T2/C Channel Setup” table.

Now check the most important parameters in the table which follows, “Channel Status”.

### Channel Status

System	DVB-T
Tuned Frequency	514000 kHz
Bandwidth	8 MHz
Carrier Offset	6 kHz
Tuner Level	68.50 dB $\mu$ V
TS Locked	yes
SNR	26.87 dB
Quality	100
C/N Value	35.70
RS Error	0
Constellation	16QAM
Guard Interval	1/4
Mode	8K
MER	31.02 dB
Pre-RS BER	0.00e+00
Pre-Viterbi BER	0.00e+00

Figure 12: Reception channel status

Ensure that you check the values in the “Quality”, “Tuner Level” and “C/N” lines here.

### Setting the signal routing to the CAM modules

Now insert the required CI module into the first slot of the U 164 if you have not already done so. Proceed as described in the section “Connecting and installing the module”. Click on the item “CAM Mux” in the web browser interface menu. You will now see the following table:

#### CAM Mux Settings

	Alias	TODO	TODO	TODO	TODO	TODO	TODO	TODO	TODO	ASTRO
	TSID ONID	TO DO	TO DO	TO DO	TO DO	TO DO	TO DO	TO DO	TO DO	65535 65535
	Status	CAM 1	CAM 2	CAM 3	CAM 4	DVBC/T RX1.1	DVBC/T RX1.2	DVBC/T RX1.3	DVBC/T RX1.4	Test Gen.
CAM 1	running	<input type="radio"/>	<input type="radio"/>	<input type="radio"/>	<input type="radio"/>	<input checked="" type="radio"/>	<input type="radio"/>	<input type="radio"/>	<input type="radio"/>	<input type="radio"/>
CAM 2	not installed	<input type="radio"/>	<input type="radio"/>	<input type="radio"/>	<input type="radio"/>	<input type="radio"/>	<input checked="" type="radio"/>	<input type="radio"/>	<input type="radio"/>	<input type="radio"/>
CAM 3	not installed	<input type="radio"/>	<input type="radio"/>	<input type="radio"/>	<input type="radio"/>	<input type="radio"/>	<input type="radio"/>	<input checked="" type="radio"/>	<input type="radio"/>	<input type="radio"/>
CAM 4	not installed	<input type="radio"/>	<input type="radio"/>	<input type="radio"/>	<input type="radio"/>	<input type="radio"/>	<input type="radio"/>	<input type="radio"/>	<input checked="" type="radio"/>	<input type="radio"/>

Submit    Reset Form

Figure 13: Signal routing to the CAM modules

In the switch matrix, click on the radio button which connects the receiver IP DVBC/T RX 1 to CAM module 1.

To save your changes, click on the “Submit” button below the table.

More information on signal routing can be found in the section “Configuring signal paths using the switch matrix”.

Now click on the item “CAM 1” in the menu at the left. (You may have to press the refresh button in your browser several times to update the page.) You will now see the following table:

#### CAM Module Information

Name	Status	Action
TSD MultiCrypt 1	running	Menu    Reset

#### Decryption Settings

#	Service		Elements	Status	Action
	Select	SID			
<input type="checkbox"/>	Please select		<input checked="" type="radio"/> all <input type="radio"/> selective		<input style="background-color: #e0ffe0;" type="button" value="+"/>

Reset Form

Figure 14: CAM settings

A list of the individual services which the module CAM 1 is receiving appears in the “Status” table. You can select the service for decryption in the “Decryption Settings” table. To add a service, click on the plus symbol in the right-hand column.

More information on decryption settings can be found in the section “Setting the decryption”.

When decryption is successful, a text which is highlighted in green appears in the status column (example: see figure at left).

Status
descrambling 4 PIDs (6 of 6 PIDs selected)

### Setting the signal routing to the IP transmitters

You can now connect the reception signal to an IP transmitter. To do so, click on the item "TX Mux" in the web browser interface menu. You will now see the following table:

#### TX Mux Settings

Alias	TODO	TODO	TODO	TODO	TODO	TODO	TODO	TODO	ASTRO
TSID ONID	TO DO	TO DO	TO DO	TO DO	TO DO	TO DO	TO DO	TO DO	65535 65535
	CAM 1	CAM 2	CAM 3	CAM 4	DVBC/T RX1.1	DVBC/T RX1.2	DVBC/T RX1.3	DVBC/T RX1.4	Test Gen.
IP TX1	<input type="radio"/>	<input type="radio"/>	<input type="radio"/>	<input type="radio"/>	<input checked="" type="radio"/>	<input type="radio"/>	<input type="radio"/>	<input type="radio"/>	<input type="radio"/>
IP TX2	<input type="radio"/>	<input type="radio"/>	<input type="radio"/>	<input type="radio"/>	<input type="radio"/>	<input checked="" type="radio"/>	<input type="radio"/>	<input type="radio"/>	<input type="radio"/>
IP TX3	<input type="radio"/>	<input type="radio"/>	<input type="radio"/>	<input type="radio"/>	<input type="radio"/>	<input type="radio"/>	<input checked="" type="radio"/>	<input type="radio"/>	<input type="radio"/>
IP TX4	<input type="radio"/>	<input type="radio"/>	<input type="radio"/>	<input type="radio"/>	<input type="radio"/>	<input type="radio"/>	<input type="radio"/>	<input checked="" type="radio"/>	<input type="radio"/>
IP TX5	<input type="radio"/>	<input type="radio"/>	<input type="radio"/>	<input type="radio"/>	<input type="radio"/>	<input type="radio"/>	<input type="radio"/>	<input type="radio"/>	<input type="radio"/>
IP TX6	<input type="radio"/>	<input type="radio"/>	<input type="radio"/>	<input type="radio"/>	<input type="radio"/>	<input type="radio"/>	<input type="radio"/>	<input type="radio"/>	<input type="radio"/>
IP TX7	<input type="radio"/>	<input type="radio"/>	<input type="radio"/>	<input type="radio"/>	<input type="radio"/>	<input type="radio"/>	<input type="radio"/>	<input type="radio"/>	<input type="radio"/>
IP TX8	<input type="radio"/>	<input type="radio"/>	<input type="radio"/>	<input type="radio"/>	<input type="radio"/>	<input type="radio"/>	<input type="radio"/>	<input type="radio"/>	<input type="radio"/>

Figure 15: Signal routing to the IP transmitters

In the switch matrix, click on the radio button which connects reception channel 1.1 to the IP transmitter IP TX 1.

To save your changes, click on the "Submit" button below the table.

More information about signal routing can be found in the "Menu TX Mux" section.

## Configuring the IP transmitter

To complete the process, you should now configure and activate the IP transmitter. To do so, click on the item "IP TX 1" in the web browser interface menu. You will now see the following table:

### IP TX1 Channel Settings

Property	Data A (eth2) 1G	Data B (eth3) 1G
Enable	<input checked="" type="radio"/> on <input type="radio"/> off	<input checked="" type="radio"/> on <input type="radio"/> off
Transmit IP:Port	172 . 24 . 0 . 150 . 0	172 . 25 . 0 . 150 . 0
Destination IP:Port	232 . 22 . 100 . 128 . 10000	232 . 21 . 100 . 128 . 10000
Destination MAC	01:00:5e:16:64:80	01:00:5e:15:64:80
TOS / TTL	184 1	184 1
VLAN (Set 0 to disable)	0	0

Enter the IP address and UDP port that the traffic is to be sent to.  
 For an IP multicast, use an address in the range 224.0.0.0 to 239.255.255.255.  
 The TOS and TTL entries are the values used for the IP "Type of Service" and "Time To Live" fields

Property	Data A (eth2) + Data B (eth3)
TS Packets per Frame	7
Protocol Encapsulation	<input checked="" type="radio"/> RTP/UDP/IP <input type="radio"/> UDP/IP
FEC (L Cols / D Rows / Interleaving)	Off Off Col only Plain

Figure 16: Configuring the IP transmitter

Enter the IP address and port of a reception device (e.g. for one of the signal converters from the U 1xx series) in the line "Destination IP Port".

In the table at the top, click on the radio button "on" to activate signal transmission to one of the data ports A or B.

To save your changes, click on the "Submit" button below the table.

More information on setting the IP transmitters can be found in the section "IP TX menu".

## Checking the data transmission rate

Now click on the item "Statistics" in the menu at the left. You will now see the following overview:

### Ethernet bandwidth

Property	Management A (eth0) 1G full	Management B (eth1) 1G full	Data A (eth2) 1G full	Data B (eth3) 1G full
Transmit	0.0 Mbit/s	0.0 Mbit/s	57.5 Mbit/s	0.0 Mbit/s
Receive	0.0 Mbit/s	0.0 Mbit/s	0.0 Mbit/s	0.0 Mbit/s

### Ethernet frames

Property	Data A (eth2) 1G	Data B (eth3) 1G
Total frames sent by host	2	0
Total frames sent to host	3	54
Total exception frames sent to host	19	2
Total errored frames received	0	0
Total frames discarded by deencapsulator	0	0
Total frames discarded because of lack of buffers	0	0
Total transmit frames generated from IP TX 1 / per sec.	107441 / 1260	0 / 0
Total transmit frames generated from IP TX 2 / per sec.	120496 / 1417	0 / 0
Total transmit frames generated from IP TX 3 / per sec.	106750 / 1260	0 / 0
Total transmit frames generated from IP TX 4 / per sec.	106461 / 1260	0 / 0

Figure 17: IP transmitter statistics

A value > 0 should now appear for the data transmission rate in the line "Transmit" in the "Ethernet bandwidth" table.  
A corresponding value should appear in the line "Total transmit frames generated from IP TX 1" in the "Ethernet frames" table.

More information about the values in the "Statistics" overview can be found in the section "Statistics menu".

Once you have successfully completed all the steps described, then the most important settings required to decrypt a data stream have been entered in the device.  
To ensure error statuses entered in the log book are easy to follow, you should configure a time source. This can be done under the menu item "Main" in the "IP Management Settings" table (also see the section "Main Menu").

## “Status” menu

To have the current settings for the U 164 displayed, click on the `Status` item in the menu at the left. You can now see the overview shown in figure 18:

### Ethernet

Property	Management A (eth0)	Management B (eth1)	Data A (eth2)	Data B (eth3)
MAC	00:17:72:02:16:81	00:17:72:03:16:81	00:17:72:04:16:81	00:17:72:05:16:81
Address	192.168.1.167	192.168.5.167	172.24.0.167	172.25.0.167
Netmask	255.255.255.0	255.255.255.0	255.255.0.0	255.255.0.0
Gateway	192.168.1.100	0.0.0.0	0.0.0.0	0.0.0.0
Mode	1 Gbit/s, full duplex	Off	1 Gbit/s, full duplex	1 Gbit/s, full duplex
Transmit	0.0 Mbit/s	0.0 Mbit/s	57.5 Mbit/s	0.0 Mbit/s
Receive	0.0 Mbit/s	0.0 Mbit/s	0.0 Mbit/s	0.0 Mbit/s

### DVB-T/T2/C Channels

Ch.	System	Input	Frequency	Tuner Level	C/N	SNR	Status
1.1	DVB-T	RF1	514 MHz	66.50 dBµV	35.70 dB	27.07 dB	ok
1.2	DVB-T	RF1	698 MHz	62.50 dBµV	20.20 dB	28.17 dB	ok
1.3	DVB-T	RF1	730 MHz	58.50 dBµV	31.00 dB	27.77 dB	ok
1.4	DVB-T	RF1	730 MHz	58.50 dBµV	30.80 dB	27.77 dB	ok

### IP TX Channels

Channel	Port	TX IP socket	Encapsulation	FEC	TSID	ONID	Alias	Status
IP TX1	A	232.21.100.128:10000	1328 bytes 7 packets RTP/UDP/IP	off	0	0		ok
	B	232.22.100.128:10000						off
IP TX2	A	232.21.100.129:10000	1328 bytes 7 packets RTP/UDP/IP	off	0	0		ok
	B	232.22.100.129:10000						off
IP TX3	A	232.21.100.130:10000	1328 bytes 7 packets RTP/UDP/IP	off	0	0		ok
	B	232.22.100.130:10000						off
IP TX4	A	232.21.100.131:10000	1328 bytes 7 packets RTP/UDP/IP	off	0	0		ok
	B	232.22.100.131:10000						off
IP TX5	A	232.21.100.132:10000	1328 bytes 7 packets RTP/UDP/IP	off	1	0		Data loss
	B	232.22.100.132:10000						off
IP TX6	A	232.21.100.133:10000	1328 bytes 7 packets RTP/UDP/IP	off	0	0		Data loss
	B	232.22.100.133:10000						off
IP TX7	A	232.21.100.134:10000	1328 bytes 7 packets	off	0	0		Data loss

Figure 18: Status display

The following tables are displayed:

### Ethernet status

Configuration data and status of the Ethernet port

### Ethernet

Property	Management A (eth0)	Management B (eth1)	Data A (eth2)	Data B (eth3)
MAC	00:17:72:02:16:da	00:17:72:03:16:da	00:17:72:04:16:da	00:17:72:05:16:da
Address	192.168.1.178	192.168.5.178	172.24.0.178	172.25.0.178
Netmask	255.255.255.0	255.255.255.0	255.255.0.0	255.255.0.0
Gateway	192.168.1.100	0.0.0.0	0.0.0.0	0.0.0.0
Mode	1 Gbit/s, full duplex	Off	1 Gbit/s, full duplex	Off
Transmit	0.0 Mbit/s	0.0 Mbit/s	57.5 Mbit/s	0.0 Mbit/s
Receive	0.0 Mbit/s	0.0 Mbit/s	0.0 Mbit/s	0.0 Mbit/s

Figure 19: Status display - Ethernet

The values for the following parameters are displayed and configured here respectively in accordance with the four connections on the backplane of the U 164 (Data A, Data B, Management A and Management B, see section “Device description”).

- MAC: MAC address (display value)
- Address: IP address (configurable)
- Netmask: Net mask (configurable)
- Gateway: Gateway IP address (configurable)
- Mode: Ethernet mode (display value)
- Transmit: Data transmission rate (display value)
- Receive: Data reception rate (display value)

**Status display of the DVB-C/T/T2 reception channels:**

**DVB-T/T2/C Channels**

Ch.	System	Input	Frequency	Tuner Level	C/N	SNR	Status
1.1	DVB-T	RF1	514 MHz	66.00 dBµV	35.70 dB	26.97 dB	ok
1.2	DVB-T	RF1	698 MHz	64.50 dBµV	32.50 dB	28.97 dB	ok
1.3	DVB-T	RF1	706 MHz	64.50 dBµV	35.70 dB	27.27 dB	ok
1.4	DVB-T	RF1	730 MHz	57.50 dBµV	31.70 dB	27.77 dB	ok

Figure 20: Status display – DVB-T/T2/C channels

The values set for the following parameters are displayed in the table “DVB-T/T2/C Channels” for the reception channels (channel 1.1 - 1.4):

- System: Reception system selected
- Input : HF input selected
- Frequency: Reception frequency set
- Tuner Level: Input level selected
- C/N: Carrier-to-noise ratio
- SNR: Signal-to-noise ratio

Details on the parameters can be found in the section “Menu Ch. X.X”.

**Status display of the IP transmitters:**

**IP TX Channels**

Channel	Port	TX IP socket	Encapsulation	FEC	TSID ONID	Alias	Status
IP TX1	A	232.16.100.128:10000	1328 bytes 7 packets	off	0 0		ok
	B	232.25.100.178:10000	RTP/UDP/IP				off
IP TX2	A	232.16.100.129:10000	1328 bytes 7 packets	off	0 0		ok
	B	232.22.100.129:10000	RTP/UDP/IP				off
IP TX3	A	232.16.100.130:10000	1328 bytes 7 packets	off	0 0		ok
	B	232.22.100.130:10000	RTP/UDP/IP				off
IP TX4	A	232.16.100.131:10000	1328 bytes 7 packets	off	0 0		ok
	B	232.22.100.131:10000	RTP/UDP/IP				off

Figure 21: Status display - IP TX channels

The values set for the following parameters are displayed in the table “IP TX Settings” for the four IP transmitters – for port A and B respectively:

- TX IP socket: Destination IP address/port
- Encapsulation: Data encapsulation
- FEC: Forward error correction
- TSID/ONID: Transport stream ID / original network ID
- Alias: Alias name

Details on the parameters can be found in the section “Menu IPTX”.

**Status display on temperature, internal voltages and the power module:**

**Miscellaneous**

Property	Mainboard	DVBC/T[1..4]	CAM[1..2]	CAM[3..4]
Temperature	50.5 °C	46.5 °C	29.5 °C	29.5 °C
Supply 1.2 V	1.19 V	1.19 V	1.20 V	1.21 V
Supply 1.8 V	1.79 V	n/a	1.79 V	1.78 V
Supply 2.5 V	2.49 V	2.48 V	2.48 V	2.48 V
Supply 3.3 V	3.31 V	3.33 V	3.29 V	3.24 V
Supply 5.2 V	5.17 V	n/a	n/a	n/a
Supply 13 V	12.88 V	n/a	n/a	n/a
Fan	9642 RPM	n/a	n/a	n/a
Supply 5.0 V	n/a	5.17 V	5.15 V	5.20 V

Figure 22: Status display - Miscellaneous



The following, general parameters are displayed in the “Miscellaneous” table:

- Temperature: Temperature display in °C for the mainboard and DVB-C/T/T2 1 - 4 and 5 - 8.
- Supply 1.2 V: 1.2 V supply voltage
- Supply 1.8 V: 1.8 V supply voltage
- Supply 2.5 V: 2.5 V supply voltage
- Supply 3.3 V: 3.3 V supply voltage
- Supply 5.2 V: 5.2 V supply voltage
- Supply 13 V: 13 V supply voltage (mainboard only)
- Fan: Fan rotation speed
- Supply 5.0 V: 5.0 V supply voltage

**Memory status:**

**System resources**

Property	Value
Total size of memory arena	58358812
Number of ordinary memory blocks	23
Space used by ordinary memory blocks	1017904
Space free for ordinary blocks	57340884
Size of largest free block	57331284
Number of left files FOPEN_MAX	59
Number of left files NFILE	50
Number of free file descriptors NFD	50
CPU load 0.1s	0 %
CPU load 1s	30 %
CPU load 10s	23 %

*Figure 23: Status display - System resources*

Information on the internal resources of the operating system can be viewed in the “System resources” table. No settings can be made here.

"Main" menu

This section explains how to enter general settings for the interfaces and the management of the U 168, as well as for the U 100 base unit.

Click on the item "Main" in the menu at the left.

**Setting the IP interfaces**

You can configure IP interfaces and activate or deactivate them using the upper table ("IP interface settings"). The connection type is automatically identified and displayed by the U 168 (in this case: 1 GBit/s, full duplex).

*NOTE: In order to make changes in this table, you must be logged in as the administrator.*

**IP Interface Settings**

Property	Management A (eth0)	Management B (eth1)	Data A (eth2)	Data B (eth3)
MAC	00:17:72:02:00:d0	00:17:72:03:00:d0	00:17:72:04:00:d0	00:17:72:05:00:d0
Active	<input checked="" type="radio"/> on <input type="radio"/> off	<input checked="" type="radio"/> on <input type="radio"/> off	<input checked="" type="radio"/> on <input type="radio"/> off	<input checked="" type="radio"/> on <input type="radio"/> off
Mode	1 Gbit/s, full duplex	1 Gbit/s, full duplex	1 Gbit/s, full duplex	1 Gbit/s, full duplex
Address	192 . 168 . 1 . 150	192 . 168 . 5 . 150	172 . 24 . 0 . 150	172 . 25 . 0 . 150
Subnet	255 . 255 . 255 . 0	255 . 255 . 255 . 0	255 . 255 . 0 . 0	255 . 255 . 0 . 0
Broadcast	192.168.1.255	192.168.5.255	172.24.255.255	172.25.255.255
Gateway	192 . 168 . 1 . 100	0 . 0 . 0 . 0	0 . 0 . 0 . 0	0 . 0 . 0 . 0

Figure 24: Configuring IP interfaces

The following parameters are displayed, and can be configured:

- MAC: MAC address of the respective interface
- Active: Activate the radio button "on" to activate the interface. Activate the radio button "off" to deactivate the interface.
- Mode: Connection type (identified automatically)
- Address: IP address
- Subnet: Netmask
- Broadcast: Broadcast address (calculated)
- Gateway: Gateway IP (if available; otherwise, set this to 0.0.0.0)

*NOTE: When programming the IP addresses, make sure the addresses have not already been allocated within your network. Address conflicts result in network malfunctions. (Please set unused parameters to 0.0.0.0.)*

To save your changes, click on the "Submit" button below the last table.

**Configuring management settings**

You can configure the following management settings in the second table ("IP management settings"):

**IP Management Settings**

Property	Value
DNS	0 . 0 . 0 . 0
SNTP server	0.0.0.0    0.0.0.0
Time Source	SNTP Server <input type="button" value="v"/>

Figure 25: Configuring management settings

Submit    Reset Form

- DNS: Enter a DNS server, if required, in the input fields.
- SNTP server: You can enter one or two time servers here (SNTP protocol).
- Time Source: “SNTP server” is set here as the default option.

To save your changes, click on the “Submit” button below the last table.

### Configuring the base unit

You can enter settings for the U 100 base unit in the third table (“U 100 Rack settings”).

#### U100 Rack Settings

Property	Value
Base Address	0
Slot Address	2
Power Modules	0

Submit    Reset Form

Figure 26: Configuring the U 100 base unit

The following parameters are displayed, and can be configured:

- Base Address: Enter an address for the base unit being used here. If the U 168 is managed using the U 100-C controller and several U 100 base units are being used, then each base unit must be allocated an address of its own. This setting only has to be entered for one module per base unit.
- Slot Address: In accordance with the coding of the backplane of the U 168 performed previously (see section “Installing and connecting”), the address corresponding to the slot in the base unit is displayed here.
- Power Modules: Select the number of power modules being monitored from the drop-down menu

To save your changes, click on the “Submit” button below the last table.

Submit    Reset Form

## Saving and loading configurations / default and reboot

Save settings to flash / Load settings from flash / Default settings / Reboot system

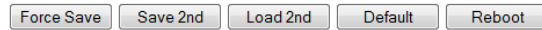

Figure 27: Saving and loading configurations

Changes to the configuration of the U 168 are written to the device by clicking the "Submit" button, and are activated immediately. If you wish to save the current status to a separate memory, click on the "Save 2nd" button (below the tables). This current status is then saved to the SD card in the U 168. By clicking on the "Load 2nd" button, you can query this status again. How to save the configuration onto the local computer or FTP server is explained in the section "Software update and configuration files". When you click the "Force Save" button, all settings are saved immediately. The time settings for automatically saving changes are then overridden.

Click on the "Default" button if you wish to restore the default settings.

**ATTENTION:** *If you click the "Default" button, all settings except for the user and network settings for the data and management ports are reset to the delivery state.*

Click on the "Reboot" button to restart the unit with the last settings saved.

## “Test generator” menu

The U 164 features an integrated test generator for a functional test when an input signal is not yet available. Null packets are generated with a preset packet ID.

### Test Generator Settings

Property	Value
Date rate	1.000000 Mbit/s (40420)
Packet ID	0
Packet length	188

Figure 28: Test generator

The following settings are displayed, and can be configured:

- Data rate: Enter the preferred data rate in MBit/s in the input field.
- Packet ID: Enter the packet ID here.
- Packet length: Packet length is displayed.

To save your changes, click on the “Submit” button below the table.

## “Channels” menu

To have an overview of the settings for the individual reception channels displayed, click on the item “Channels” in the menu at the left.

### Checking the settings for the DVB-C/T/T2

You can check the settings for the input channels in the upper table, “DVB-T/T2/C Channel overview”, and activate or deactivate the individual channels.

#### DVB-T/T2/C Channel overview

Ch.	Enable	System	Input	Frequency	Tuner Level	C/N	SNR	Status
1.1	<input type="radio"/> on <input checked="" type="radio"/> off	DVB-T	RF1	514 MHz	66.50 dBµV	35.70 dB	27.07 dB	ok
1.2	<input type="radio"/> on <input checked="" type="radio"/> off	DVB-T	RF1	698 MHz	62.50 dBµV	20.20 dB	28.17 dB	ok
1.3	<input type="radio"/> on <input checked="" type="radio"/> off	DVB-T	RF1	730 MHz	58.50 dBµV	31.00 dB	27.77 dB	ok
1.4	<input type="radio"/> on <input checked="" type="radio"/> off	DVB-T	RF1	730 MHz	58.50 dBµV	30.80 dB	27.77 dB	ok

#### RF Input Settings

Channel 1.x	
Input Attenuator	0.0 dB
RF Input	RF1
RF Supply Voltage	<input type="radio"/> off <input checked="" type="radio"/> on

Figure 29: “DVB-T/T2/C Channel overview” and “RF Input Settings” tables

The signal forwarding to the multiplexer (TX Mux) can be activated or deactivated respectively in the “Enable” column by clicking the corresponding radio button.

The following parameters are displayed for the four reception channels (Ch 1.1 - 1.4) respectively:

- System: Display of the reception system selected
- Input: Display of the input signal received (for reception channels Ch 1.1 - 1.4, this is always RF 1)
- Frequency: Reception frequency selected
- Tuner Level: Output level set for the respective reception channel
- C/N: Carrier-to-noise ratio
- SNR: Signal-to-noise ratio

The “RF Input Settings” table which follows allows you to:

- Enter an input attenuation value for the two front ends respectively
- Activate or deactivate the HF supply voltage for the two frontends respectively

If you change the activation or deactivation status of inputs or outputs in one of the two tables, then click on the “Submit” button below the last table to save your changes. Click on “Reset form” to restore the original settings.

To configure the four reception channels, start by clicking, in the menu at the left, on the item “Ch. 1.1”, “Ch. 1.2”, “Ch. 1.3” or “Ch. 1.4”. The following table will then appear in the content area at the top:

**DVB-T/T2/C Channel Setup**

Channel Parameters	
Channel Number	1.1
Channel Status	ok
RF Input	RF1
Channel enabled	<input checked="" type="radio"/> on <input type="radio"/> off
DVB System	DVB-T ▾
Center Frequency	26 (514 MHz) ▾
	manual freq.: <input type="text"/> kHz
Tune Offset	0 <input type="text"/> kHz
Tuning parameters	<input checked="" type="radio"/> Auto <input type="radio"/> Manual (Parameters below)

DVB-C Parameters	
Symbol Rate (Bandwidth)	< 6.96 MBaud (8 MHz) ▾

DVB-T Parameters	
Channel Bandwidth	8 MHz ▾
Guard Interval	1/8 ▾
Mode	8K ▾
Profile	HP ▾

DVB-T2 Parameters	
Channel Bandwidth	8 MHz ▾
PLP	0 <input type="text"/>

Figure 30: “DVB-T/T2/C Channel Setup” table

The following settings can also be entered individually:

- Channel enabled: To activate or deactivate the channel, select the corresponding radio button.
- DVB System: Select the preferred reception system from the drop-down menu (DVB-C, DVB-T or DVB-T2).
- Center Frequency: Select the preferred reception frequency from the drop-down menu. If you select the item “manual” from the list, you can enter the required value, in kHz, in the “manual freq.” input field.
- Tune Offset: You can enter a frequency offset to the centre frequency here.
- Tuning parameters: Click the corresponding radio button to select whether the reception parameters for the preferred reception system should be set automatically or manually. When you activate “manual”, you can configure the reception parameters in the table in the sections which follow.

**Setting DVB-C parameters:**

Symbol Rate (Bandwidth) : Select the preferred symbol rate from the drop-down menu.

**Setting DVB-T parameters:**

Channel Bandwidth: Select the preferred channel bandwidth from the drop-down menu (6, 7 or 8 MHz).

Guard Interval: Select the preferred guard interval from the drop-down menu (1/4, 1/8, 1/16 or 1/32).

Mode: Select the preferred mode from the selection list (2k or 8k).

Profile: Select the preferred profile from the drop-down menu (HP or LP).

Click on the "Submit" button below the last table to save the changes.  
Click on "Reset form" to restore the original settings.

The "Channel Status" table which follows provides an overview of the parameters currently set for the selected reception channel (see below).

**Channel Status**

System	DVB-T
Tuned Frequency	514000 kHz
Bandwidth	8 MHz
Carrier Offset	6 kHz
Tuner Level	68.50 dBµV
TS Locked	yes
SNR	26.87 dB
Quality	100
C/N Value	35.70
RS Error	0
Constellation	16QAM
Guard Interval	1/4
Mode	8K
MER	31.02 dB
Pre-RS BER	0.00e+00
Pre-Viterbi BER	0.00e+00

Figure 31: "Channel Status" table



## “CAM Mux” menu

You can configure the receiver routing to the four CAM modules using this menu item.

**NOTE:** An overview of the possible signal paths can be found in the “Quick start – starting operation of the U 164” section.

Start by clicking on the menu item “CAM Mux” in the menu at the left. You will now see the following table:

### CAM Mux Settings

	Alias	TODO	TODO	TODO	TODO	TODO	TODO	TODO	TODO	ASTRO
	TSID ONID	TO DO	TO DO	TO DO	TO DO	TO DO	TO DO	TO DO	TO DO	65535 65535
	Status	CAM 1	CAM 2	CAM 3	CAM 4	DVBC/T RX1.1	DVBC/T RX1.2	DVBC/T RX1.3	DVBC/T RX1.4	Test Gen.
CAM 1	running	<input type="radio"/>	<input checked="" type="radio"/>	<input checked="" type="radio"/>	<input checked="" type="radio"/>	<input checked="" type="radio"/>	<input type="radio"/>	<input type="radio"/>	<input type="radio"/>	<input type="radio"/>
CAM 2	not installed	<input type="radio"/>	<input type="radio"/>	<input type="radio"/>	<input type="radio"/>	<input type="radio"/>	<input checked="" type="radio"/>	<input type="radio"/>	<input type="radio"/>	<input type="radio"/>
CAM 3	not installed	<input type="radio"/>	<input type="radio"/>	<input type="radio"/>	<input type="radio"/>	<input type="radio"/>	<input type="radio"/>	<input checked="" type="radio"/>	<input type="radio"/>	<input type="radio"/>
CAM 4	not installed	<input type="radio"/>	<input type="radio"/>	<input type="radio"/>	<input type="radio"/>	<input type="radio"/>	<input type="radio"/>	<input type="radio"/>	<input checked="" type="radio"/>	<input type="radio"/>

Submit    Reset Form

Figure 32: Output switch matrix “CAM Mux Settings”

You can forward the respective output signal from a reception channel to one of the CAM modules by clicking on the corresponding radio button. Furthermore, the output signal from each CAM module can be forwarded on to one of the other CAM modules.

If no input signal is available, you can also forward the signal from the test generator (see “Test generator” section) to the respective CAM modules.

The transport stream ID, the network ID and the alias name for each source are displayed respectively in the upper part of the table.

Click on the “Submit” button below the table to save the changes. Click on “Reset form” to restore the original settings.

**NOTE:** The “Quick start – starting operation of the U 164” section includes a configuration example.

Submit    Reset Form

## "CAM 1 - CAM 4" menu

This section tells you how to make the decryption settings for the four CAM modules. The procedure is described in the following.

To have the input screen for the module configuration displayed, click on one of the items "CAM1", "CAM2", "CAM3" or "CAM4" in the menu at the left.

### CAM module information

The respective name of the module as well as the current status is displayed in the upper table. If the module is functioning properly, the message "running" appears. If a CAM module has not been installed, then the message reads "no CAM installed". Other error messages are "CAM error temperature too high" and "voltage error".

#### CAM Module Information

	Name	Status	Action
+	AlphaCrypt Pro	running	Menu

Figure 33: CAM module information

Click on the "+" symbol in the left column to have an overview of the CA systems displayed. If you click on the "Menu" button in the right column, the MM menu for the module opens.

### Entering decryption settings

The second table allows you to add the service for decryption and – if preferred – to limit the decryption to individual elements.

#### Decryption Settings

#	Service		Elements	Status	Action
	Select	SID			
<input type="checkbox"/>	Please select		<input checked="" type="radio"/> all <input type="radio"/> selective		

Figure 34: Selecting services for decryption

To add a service, start by selecting the service in the "Select" column, or enter the SIDs manually in the input fields. Click on the "+" symbol in the right column. The service will now be added.

You can set different SIDs for the redundant sources of reception.

Details on the redundancy concept can be found in the section "IP RX menu".

Depending on the active source, either Primary, Secondary or Tertiary is flagged as active.



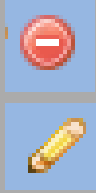

**NOTE:** If you wish to delete a service from the list, then click on the red symbol in the column at the right.

If you wish to select individual elementary streams, click on the pencil symbol to activate the service. You can select whether the full service ("all") or only individual elements ("selective") should be decrypted in the "Elements" column. Click on the corresponding radio button to do so. If you select the option "selective", another table is expanded in which the individual elementary streams can be selected.

**Decryption Settings**

Service		Elements	Status	Action																				
#	Select	SID																						
1	Manual SID	234	<input type="radio"/> all <input checked="" type="radio"/> selective																					
<table border="1"> <thead> <tr> <th colspan="2">Element</th> <th>Action</th> </tr> <tr> <th>Select by</th> <th>Value</th> <th></th> </tr> </thead> <tbody> <tr> <td>PID</td> <td>123</td> <td><input type="button" value="-"/></td> </tr> <tr> <td>Content</td> <td>Video</td> <td><input type="button" value="-"/></td> </tr> <tr> <td>Content</td> <td>Audio Lang: all or</td> <td><input type="button" value="-"/></td> </tr> <tr> <td>Stream Type</td> <td>0x07 - ISO/IEC 13522 MHEG</td> <td><input type="button" value="-"/></td> </tr> <tr> <td>Please select</td> <td></td> <td><input type="button" value="+"/></td> </tr> </tbody> </table>		Element		Action	Select by	Value		PID	123	<input type="button" value="-"/>	Content	Video	<input type="button" value="-"/>	Content	Audio Lang: all or	<input type="button" value="-"/>	Stream Type	0x07 - ISO/IEC 13522 MHEG	<input type="button" value="-"/>	Please select		<input type="button" value="+"/>	descrambling 5 PIDs (5 of 8 PIDs selected)	<input checked="" type="button" value="✓"/> <input type="button" value="-"/>
Element		Action																						
Select by	Value																							
PID	123	<input type="button" value="-"/>																						
Content	Video	<input type="button" value="-"/>																						
Content	Audio Lang: all or	<input type="button" value="-"/>																						
Stream Type	0x07 - ISO/IEC 13522 MHEG	<input type="button" value="-"/>																						
Please select		<input type="button" value="+"/>																						
<input type="checkbox"/> Please select		<input type="radio"/> all <input type="radio"/> selective	<input type="button" value="+"/>																					

Figure 35: Selecting specific service elements

You can choose between the options "PID", "Content" and "Stream Type" in the "Select by" column.

The "PID" options allows selection according to the elementary stream PID. Enter the preferred PID in the input field manually.

The "Content" option allows selection according to the content of the elementary streams. A drop-down menu with the following options appears in the "Value(s)" column:

- Video: All video elementary streams are decrypted.
- Audio\*: All audio elementary streams are decrypted.
- Teletext\*: The elementary streams for all languages are decrypted.
- Subtitling\*: When you select this option, the elementary streams for the subtitles are decrypted.

\*) Two input fields for language selection appear to the right of the selection list, in which you can enter the preferred language or an alternative language as an abbreviation.

The "Stream Type" options allows selection of the elementary streams according to DVB stream type.

Your changes are applied as soon as either the Plus button or the Tick button is clicked. Click on "Reset form" to restore the original settings.

Reset Form

### Status display

An overview of the decryption status is displayed in the third table (see figure 32, below). The respective SID appears in the left column, with the middle column showing the selected service and the current status of the decrypted PIDs appearing in the right column. If no decryption occurs, then "no processing" appears.

Status

SID	Service	Status
13001	<b>ORF1, ORF</b>	descrambling 4 PIDs (4 of 6 PIDs selected)
13002	<b>ORF2, ORF</b>	descrambling 3 PIDs (5 of 5 PIDs selected)
13003	<b>ORF2 W, ORF</b>	no processing
13004	<b>ORF2 N, ORF</b>	no processing
13005	<b>ORF2 B, ORF</b>	no processing
13006	<b>ORF2 O, ORF</b>	no processing
13007	<b>ORF2 S, ORF</b>	no processing
13008	<b>ORF2 T, ORF</b>	no processing
13009	<b>ORF2 V, ORF</b>	no processing
13010	<b>ORF2 St, ORF</b>	no processing
13011	<b>ORF2 K, ORF</b>	no processing
13012	<b>ATV, ATV+</b>	no processing
13013	HITRADIO OE3, ORF	no processing
13014	ORF2E, ORF	no processing
13019	RIC, -	no processing
13200	AlphaCrypt, ORF	no processing
13221	Crenova OTA Service, ORS	no processing

Figure 36: Decryption status display

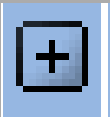

Services marked in bold type include at least one encrypted service.

Click on the "+" symbol in the left column to have the detailed settings for decryption displayed.

Status

SID	Service						Status
13001	<b>ORF1, ORF</b>						descrambling 4 PIDs (4 of 6 PIDs selected)
PID	Type	Content	Language	Input	Output	Status	
160	0x02	ISO/IEC 13818-2 Video		scrambled	free	descrambling	
161	0x03	ISO/IEC 11172 Audio	ger	scrambled	free	descrambling	
162	0x03	ISO/IEC 11172 Audio	eng	scrambled	free	descrambling	
163	0x06	ISO/IEC 13818-1 Private PES data packets	ger	scrambled	free	descrambling	
165	0x06	ISO/IEC 13818-1 Private PES data packets (Teletext)	ger	free	free	no processing	
169	0x06	ISO/IEC 13818-1 Private PES data packets		free	free	no processing	

Figure 37: Status details display

The advanced view shows all the settings made in the "Decryption Settings" table (decrypted PIDs, type, selected content, language). Furthermore, it shows whether the content is encrypted or unencrypted ("scrambled" or "free").

The "Output" column shows whether the content of the output signal is unencrypted for the respective PID. The "Status" column shows whether the PID is being decrypted ("descrambling" or "no processing") or whether errors have occurred.

To have an overview of the 8 IP outputs displayed, start by clicking on the “IP TX” item in the menu at the left. The following table will then appear in the content area:

**IP TX Channel Settings**

Channel	Enable	Length	Packets	Mode	Destination IP socket	UDP src	TOS	TTL	VLAN
IP TX1	Data A: <input type="radio"/> on <input type="radio"/> off	188	7	RTP/UDP/IP	232.21.100.128:10000	0	184	1	0
	Data B: <input type="radio"/> on <input type="radio"/> off				232.22.100.128:10000				
IP TX2	Data A: <input type="radio"/> on <input type="radio"/> off	188	7	RTP/UDP/IP	232.21.100.129:10000	0	184	1	0
	Data B: <input type="radio"/> on <input type="radio"/> off				232.22.100.129:10000				
IP TX3	Data A: <input type="radio"/> on <input type="radio"/> off	188	7	RTP/UDP/IP	232.21.100.130:10000	0	184	1	0
	Data B: <input type="radio"/> on <input type="radio"/> off				232.22.100.130:10000				
IP TX4	Data A: <input type="radio"/> on <input type="radio"/> off	188	7	RTP/UDP/IP	232.21.100.131:10000	0	184	1	0
	Data B: <input type="radio"/> on <input type="radio"/> off				232.22.100.131:10000				
IP TX5	Data A: <input type="radio"/> on <input type="radio"/> off	188	7	RTP/UDP/IP	232.21.100.132:10000	0	184	1	0
	Data B: <input type="radio"/> on <input type="radio"/> off				232.22.100.132:10000				
IP TX6	Data A: <input type="radio"/> on <input type="radio"/> off	188	7	RTP/UDP/IP	232.21.100.133:10000	0	184	1	0
	Data B: <input type="radio"/> on <input type="radio"/> off				232.22.100.133:10000				
IP TX7	Data A: <input type="radio"/> on <input type="radio"/> off	188	7	RTP/UDP/IP	232.21.100.134:10000	0	184	1	0
	Data B: <input type="radio"/> on <input type="radio"/> off				232.22.100.134:10000				
IP TX8	Data A: <input type="radio"/> on <input type="radio"/> off	188	7	RTP/UDP/IP	232.21.100.135:10000	0	184	1	0
	Data B: <input type="radio"/> on <input type="radio"/> off				232.22.100.135:10000				

Figure 38: “IP TX channel settings” table

The following parameters are displayed for the 8 output channels respectively:

- Enable**: Each of the 8 output signals can be routed to either Ethernet output A or B, or to both Ethernet outputs.  
Activate the radio buttons which correspond to your selection.
- Length**: Packet length
- Packets**: TS packets per IP packet
- Mode**: Protocol encapsulation (RTP/UDP/IP or UDP/IP)
- Destination IP socket**: Destination address/port
- Protocol Encapsulation**: Select either “RTP/UDP/IP” or “UDP/IP” as the protocol by clicking the corresponding radio button.
- UDP src**: UPD source
- TOS**: Type of service
- VLAN**: Virtual LAN ID

Click on the “Submit” button below the last table to save the changes made to the activation/deactivation of channels.

Click on “Reset form” to restore the original settings.

## "IP TX 1 - IP TX 8" menu

To configure the 8 IP outputs, start by clicking, in the menu at the left, on the item "IP TX 1", "IP TX 2", "IP TX 3" to "IP TX 8". The following table will then appear in the content area at the top:

### IP TX1 Channel Settings

Property	Data A (eth2) 1G	Data B (eth3) 1G
Enable	<input checked="" type="radio"/> on <input type="radio"/> off	<input checked="" type="radio"/> on <input type="radio"/> off
Transmit IP:Port	172 . 24 . 0 . 150 . 0	172 . 25 . 0 . 150 . 0
Destination IP:Port	232 . 22 . 100 . 128 . 10000	232 . 21 . 100 . 128 . 10000
Destination MAC	01:00:5e:16:64:80	01:00:5e:15:64:80
TOS / TTL	184 1	184 1
VLAN (Set 0 to disable)	0	0

Figure 39: Table 1 "IP TX1 channel settings"

You can activate or deactivate forwarding of the selected IP output to ports A and B respectively by clicking on the corresponding radio button. The MAC address is displayed for ports A and B respectively ("Destination MAC").

You can enter one value for ports A and B respectively for the following parameters:

- Transmit IP: Port: Enter the transmit IP address and port here.
- Destination IP: Port: Enter the destination IP address and port here.
- TOS/TTL: You can enter a value for the "Type of service" here (which is used for prioritising the IP data packets). Enter a value for the validity period here ("Time to Live").
- VLAN (Set 0 to disable): Enter the address of a virtual local network here.

Another table is shown in the following in which settings valid for data ports A and B can be entered.

Property	Data A (eth2) + Data B (eth3)
TS Packets per Frame	7
Protocol Encapsulation	<input checked="" type="radio"/> RTP/UDP/IP <input type="radio"/> UDP/IP
FEC (L Cols / D Rows / Interleaving)	Off Off Col only Plain

Figure 40: Table 2 "IP TX1 channel settings"

- TS Packets per Frame: The number of transport stream packets per frame; select a value between 1 and 7 from the drop-down menu.
- Protocol Encapsulation: Select either "RTP/UDP/IP" or "UDP/IP" as the protocol by clicking the corresponding radio button.
- FEC: Forward error correction  
 Select the number of columns from the first drop-down menu ("off" or a value between 1 and 20).  
 Select the number of rows from the second drop-down menu ("off" or a value between 4 and 20).  
 Select one of the two options, "Columns and rows" (Col + Rows) and "Column only" (Col only) from the third drop-down menu.  
 Select one of the options "Plain", or "Annex A" or "Annex B" respectively, from the fourth drop-down menu.

Click on the "Submit" button below the last table to save the changes.  
 Click on "Reset form" to restore the original settings.

You can configure the routing to the IP transmitter using this menu item.

**NOTE:** An overview of the possible signal paths can be found in the “Quick start – starting operation of the U 164” section.

Start by clicking on the menu item “TX Mux” in the menu at the left. You will now see the following table:

**TX Mux Settings**

Alias	TODO	TODO	TODO	TODO	TODO	TODO	TODO	TODO	ASTRO
TSID ONID	TO DO	TO DO	TO DO	TO DO	TO DO	TO DO	TO DO	TO DO	65535 65535
	CAM 1	CAM 2	CAM 3	CAM 4	DVBC/T RX1.1	DVBC/T RX1.2	DVBC/T RX1.3	DVBC/T RX1.4	Test Gen.
IP TX1	<input type="radio"/>	<input type="radio"/>	<input type="radio"/>	<input type="radio"/>	<input checked="" type="radio"/>	<input type="radio"/>	<input type="radio"/>	<input type="radio"/>	<input type="radio"/>
IP TX2	<input type="radio"/>	<input type="radio"/>	<input type="radio"/>	<input type="radio"/>	<input type="radio"/>	<input checked="" type="radio"/>	<input type="radio"/>	<input type="radio"/>	<input type="radio"/>
IP TX3	<input type="radio"/>	<input type="radio"/>	<input type="radio"/>	<input type="radio"/>	<input type="radio"/>	<input type="radio"/>	<input checked="" type="radio"/>	<input type="radio"/>	<input type="radio"/>
IP TX4	<input type="radio"/>	<input type="radio"/>	<input type="radio"/>	<input type="radio"/>	<input type="radio"/>	<input type="radio"/>	<input type="radio"/>	<input checked="" type="radio"/>	<input type="radio"/>
IP TX5	<input type="radio"/>	<input type="radio"/>	<input type="radio"/>	<input type="radio"/>	<input type="radio"/>	<input type="radio"/>	<input type="radio"/>	<input type="radio"/>	<input type="radio"/>
IP TX6	<input type="radio"/>	<input type="radio"/>	<input type="radio"/>	<input type="radio"/>	<input type="radio"/>	<input type="radio"/>	<input type="radio"/>	<input type="radio"/>	<input type="radio"/>
IP TX7	<input type="radio"/>	<input type="radio"/>	<input type="radio"/>	<input type="radio"/>	<input type="radio"/>	<input type="radio"/>	<input type="radio"/>	<input type="radio"/>	<input type="radio"/>
IP TX8	<input type="radio"/>	<input type="radio"/>	<input type="radio"/>	<input type="radio"/>	<input type="radio"/>	<input type="radio"/>	<input type="radio"/>	<input type="radio"/>	<input type="radio"/>

Submit Reset Form

Figure 41: Output switch matrix “TX Mux Settings”

You can forward the respective output signal from a reception channel to an IP output by clicking on the corresponding radio button. Furthermore, you can transmit each of the output signals from the CAM modules 1 - 4 to an IP output. If no input signal is available, you can also forward the signal from the test generator (see “Test generator” section) to the respective IP outputs.

The transport stream ID, the network ID and the alias name for each source are displayed respectively in the upper part of the table.

Click on the “Submit” button below the table to save the changes. Click on “Reset form” to restore the original settings.

**NOTE:** The “Quick start – starting operation of the U 164” section includes a configuration example.

Submit Reset Form

## “User Settings” menu

Click on the menu item “User Settings” in the main menu at the left to have the corresponding input mask displayed. The following input mask now appears:

### User Administration

Property	Username	New Password	Retype New Password	Delete
Admin account	admin			
User account 1	user			<input type="checkbox"/>
User account 2	controller			<input type="checkbox"/>
User account 3				<input type="checkbox"/>
Timeout	10 minutes			
Name	ASTRO EdgeStreamer U168			
Location	Headend in Cablecity			
Contact	John Doe. admin@example.com			
Enforce password policy	<input checked="" type="checkbox"/>			
Disallow anonymous access	<input type="checkbox"/>			

Figure 42: User administration

You can create up to four users for the user interface of the U 168. The following three users have been created as the default setting:

- admin
- user
- controller

Users logged in as administrator can change all of the settings in the user interface. A number of settings are not accessible for other user groups (e.g. “IP Interface Settings” table in the “Main” menu). The password for all three users is “astro”.

To change the access data for a user account, or to create a new one, enter the preferred user name in the input field `User name`. Then enter the preferred password in the input field `New Password`, and confirm it by typing it in the input field `Retype New password` again.

**NOTE:** A password must contain at least 5 characters. You can increase the minimum requirements for passwords using the “Enforced Password Policy” option (see below).

To delete a user account, activate the corresponding checkbox `Delete` for the respective account in the right column of the table.

The following settings can also be entered:

- Timeout:** You can enter a time for the automatic logout, in minutes, in this input field. If no more inputs are made in the user interface, then automatic logout will occur once the time entered here has elapsed.  
The time remaining until automatic logout is displayed under the main menu, in the left column of the user interface.
- Name, Location, Contact:** You can save a name for the system, the location and the contact data for a person in these input fields. They are displayed in the status line.
- Enforced Password Policy:** Activate the checkbox when a password should have a minimum of 8 characters, and include at least one lower-case letter, one upper-case letter, one number and one special character.
- Disallow anonymous access:** Activate the checkbox when access to the content area (tables) should only be possible after logging in.



Submit    Reset Form

**IMPORTANT:** All changes will only be applied after you have clicked on the “Submit” button below the input mask. Click on the “Reset Form” button to delete the input values again.

Another table follows in which you can enter information for a RADIUS server. A licence is also required for the RADIUS server function.

**RADIUS Administration**

RADIUS Server Address	123.0.0.0
RADIUS Server Port	1812
RADIUS Shared Secret	
RADIUS Retries	3
RADIUS Timeout	2
Enable RADIUS login	<input type="checkbox"/>

Figure 43: RADIUS administration

The following items of information can be entered individually:

- RADIUS Server Address
- RADIUS Server Port
- RADIUS Shared Secret
- RADIUS Server Retries
- RADIUS Server Timeout
- Enable RADIUS Log-in

**NOTE:** Users who have been configured on the device will be deactivated when a RADIUS server is configured.

The RADIUS server must be configured accordingly. Users with the service type “Administrative” are the device administrators.

When you click the checkbox “Enable Radius login”, the RADIUS function is activated if the RADIUS server is able to be reached. If this is not the case, the RADIUS function remains inactive, and the message “RADIUS logins have not been enabled because the connection check failed” appears.

You can create a white list for all incoming IP data in a further table. In this case, only IP data will be processed which come from a source entered in the white list.

	Address				Netmask			
IP Whitelist 1	0	0	0	0	0	0	0	0
IP Whitelist 2	0	0	0	0	0	0	0	0
IP Whitelist 3	0	0	0	0	0	0	0	0
IP Whitelist 4	0	0	0	0	0	0	0	0

Figure 44: White list administration

The following parameters can be specified for four IP sources respectively:

- IP address
- Netmask

“SSL Settings” menu

**NOTE:** A licence is required to use the SSL functions.

To enter SSL settings, click on the item “SSL Settings” in the main menu at the left.

There is a checkbox in the upper table “SSL Settings” which displays the redirection of HTTP requests to the secure protocol HTTPS. After input of the licence, the checkbox is activated.

Setting	Value
Redirect HTTP requests to HTTPS	<input type="checkbox"/>

Figure 45: “SSL settings” table

In the following table, “Generate a CSR for this device”, individual items of information about the device can be entered (“Certificate Signing Request”: address, organisation, etc.).

**Generate a CSR for this device**

CSR Attribute	Value
Private key in use	generated by device
Country (C)	DE
State (ST)	
Locality (L)	
Organization (O)	
Organizational Unit (OU)	
Common Name (CN)	192.168.1.153
Generate CSR with above data	<input type="button" value="Download CSR"/>

Figure 46: “Generate a CSR for this device” table

By clicking the “Download CSR” button, you can create a “Certificate Signing Request” with which your CA can issue a certificate for the device. The input field “Private key in use” shows you whether the device’s own key, or the key which was entered and saved, is being used.

There is a third table, “Key and certificate settings”, below this.

**Key and certificate settings**

Upload device key in PEM format	<input type="button" value="Durchsuchen..."/> Keine Datei ausgewählt.	<input type="button" value="Upload key"/>
Clear supplied key	<input type="button" value="Clear key"/>	
Upload device certificate in PEM format	<input type="button" value="Durchsuchen..."/> Keine Datei ausgewählt.	<input type="button" value="Upload certificate"/>
Clear supplied certificate	<input type="button" value="Clear certificate"/>	
Regenerate device key and certificate	<input type="button" value="Regenerate"/>	

Figure 47: “Key and certificate settings” table

“

This table allows you to:

- Upload a device key (click on the “Search” button and select the preferred file; then click on the “Upload key” button)
- Delete an existing device key (click the “Clear key” button)
- Upload a device certificate (click on the “Search” button and select the preferred file; then click on the “Upload certificate” button)
- Delete an existing device certificate (click the “Clear certificate” button)
- Regenerate a device key and device certificate (click the “Regenerate” button)

The device administrators two keys/pairs of certificates: “generated” and “user”. The following figure shows which certificate and which key are used.

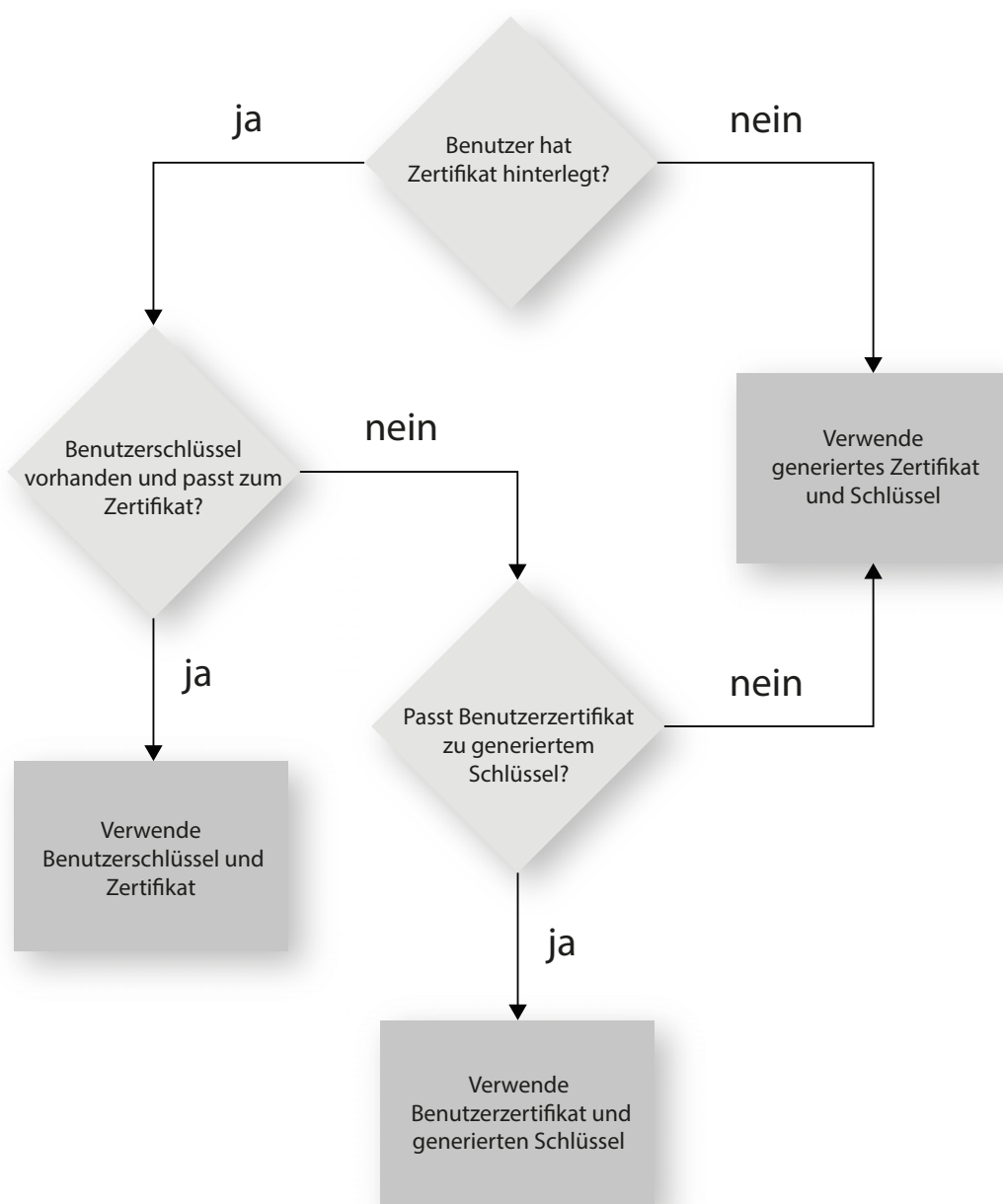

Figure 48: Using the certificates/keys

## “TS Analyzer” menu

The U 168 descrambler can be equipped with a Transport Stream Analyzer by purchasing a licence. This Analyzer displays the structure of the MPEG2 TS, from the tables to the individual PID and its service. Click on the “TS Analyzer” submenu to access and select the transport stream for analysis. The following input mask now appears:

### TS Analyzer

Alias	ORF1 ORF				ORF1 ORF	ORF1 ORF	ASTR O ASTR O	ASTR O ASTR O	ASTRO
TSID	1117	0	0	0	1117	1117	65535	65535	65535
ONID	1	0	0	0	1	1	65535	65535	65535
Source	IP RX1	IP RX2	IP RX3	IP RX4	CAM 1	CAM 2	CAM 3	CAM 4	Test Gen.
Analyze	<input checked="" type="radio"/>	<input type="radio"/>	<input type="radio"/>	<input type="radio"/>	<input type="radio"/>	<input type="radio"/>	<input type="radio"/>	<input type="radio"/>	<input type="radio"/>

Standard	Table			
MPEG	<input checked="" type="checkbox"/> PAT	<input checked="" type="checkbox"/> CAT	<input type="checkbox"/> TSdT	<input checked="" type="checkbox"/> PMTs
DVB	<input checked="" type="checkbox"/> NIT actual	<input type="checkbox"/> NIT other (only first found)	<input checked="" type="checkbox"/> SDT actual	<input type="checkbox"/> SDT other (only first found)
	<input type="checkbox"/> EIT actual present/following	<input type="checkbox"/> EIT actual schedule	<input type="checkbox"/> BAT (only first found)	<input type="checkbox"/> RST (only first found)
	<input checked="" type="checkbox"/> TDT	<input type="checkbox"/> TOT		

Please be patient until measurements are finished. (e.g. EIT may take a long time.)

[No License](#)

ASTRO Strobel Kommunikationssysteme GmbH

Figure 49: Transport stream analyzer

To analyse a transport stream, click on the corresponding radio button in the “Analyze” line and then click on the “Submit” button. If you wish to reset your inputs, click on the “Reset” button.

**NOTE:** The two buttons “Submit” and “Reset” are only visible when this module has been licensed. If this is not the case, the link “No licence” will appear instead. Click on this, or the item “Licence” in the menu at the left, to access the “Licensing” input mask (more detailed explanation of this is found in the section “Licensing”).

Submit

Reset Form

## “Licensing” menu

A number of functions of the U 168 (e.g. the TS Analyzer) can only be used after being enabled by means of a licence key.

The licence key with the respective function can be purchased from ASTRO. You will receive a licence key with which you can activate the functions using the web browser interface.

The format of the licence key is a text document (e.g. Lic001772000222.txt).

To activate the functions, start by clicking on the “Licensing” item in the menu at the left. The following input mask now appears:

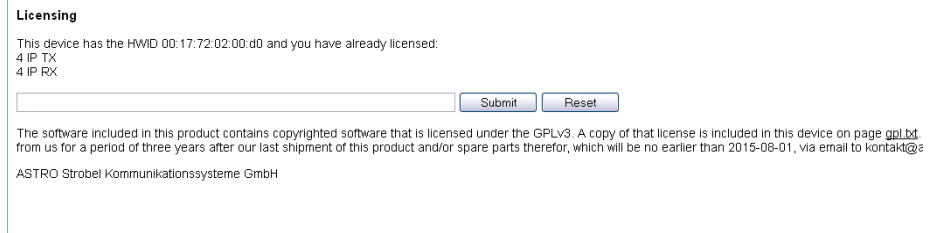

**Licensing**

This device has the HWID 00:17:72:02:00:d0 and you have already licensed:  
 4 IP TX  
 4 IP RX

The software included in this product contains copyrighted software that is licensed under the GPLv3. A copy of that license is included in this device on page [gpl.txt](#) from us for a period of three years after our last shipment of this product and/or spare parts therefor, which will be no earlier than 2015-08-01, via email to [kontakt@astro-strobel.de](mailto:kontakt@astro-strobel.de)

ASTRO Strobel Kommunikationssysteme GmbH

*Figure 50: Enabling licences using the licence key*

Now enter the licence key sent to you in the input field. The key or keys can be entered in the input mask using “Copy & Paste”. Then click on the “Submit” button to transmit the text to the device. If the licence is valid, this is confirmed with the message “License is valid”. An error message is displayed for an invalid licence.

To order additional licences, the MAC address of the device must be specified. You will find the MAC address on the web browser interface in the “Licensing” submenu (HWID). After the MAC address has been submitted, the licence keys are generated by ASTRO are sent by e-mail or on a CD.



## “Update/config.” menu

The menu item “Update/config.” allows you to update the firmware version of your device and upload and download a variety of configuration data.

### Firmware update from a local memory location

You will require an update archive for updating the device firmware. This can be downloaded from the ASTRO firmware server (address: “http://astro-firmware.de/Headend-Firmware/u1xx”). The file name of the archive required ends in “.up”. The name is comprised of the type designation of the device (U 168) and a four-digit version number.

Once the update archive has been downloaded, start by selecting the item “Update/config.” in the user interface menu. The “Software update” table then appears in the content area at the top.

#### Software Update

Property	Value
File	<input type="button" value="Durchsuchen..."/> Keine Datei ausgewählt <input type="button" value="Update and reboot"/>
Software archive	<a href="#">u168xxxx.up</a>

Figure 51: Firmware update

Now click on the “Search” button and select the path to the memory location of the update archive downloaded beforehand.

Then click on the “Update and Reboot” button to start the update process. Please wait for the process to be completed, and for the device to reboot.

### Uploading and downloading configuration files

#### Config files (download/upload)

Property	Value
File	<input type="button" value="Durchsuchen..."/> Keine Datei ausgewählt <input type="button" value="Upload"/>
System settings	<a href="#">settings.xml</a>

Figure 52: Loading/saving configuration files

Configuration files can be uploaded and downloaded.

To upload files, use the “Search” button to select the preferred file. Then click on the “Upload” button to start the uploading process.

The following files are available for download:

- [System settings \(XML format\)](#)

Simply click on the corresponding file link to download the file.

## Downloading configuration/status files

### Config/status files (read only)

Property	Value
Module info	<a href="#">module.xml</a>
IP configuration	<a href="#">ip.xml</a>
System status	<a href="#">status.xml</a>
System measurements	<a href="#">measure.xml</a>

Figure 53: Loading status files

The following files are available for download:

- Module info (XML format)
- IP configuration (XML format)
- System status (XML format)
- System measurements (XML format)

Simply click on the corresponding file link to download the file.

## Loading/saving firmware and configurations using (T)FTP

You can update firmware using a (T)FTP server using the table “Firmware update and configuration via server” and load or save configuration files.

### Firmware update and configuration via server

Property	Value
(T)FTP Server address	<input type="text" value="astro-firmware.de"/>
Protocol	<input checked="" type="radio"/> FTP <input type="radio"/> TFTP
FTP Username (e.g. anonymous)	<input type="text" value="anonymous"/>
FTP Password (e.g. guest)	<input type="password" value="•••••"/>
Path	<input type="text" value="/Headend-Firmware/u1xx/"/>
Version	<input type="text"/>
Mode	<input type="text" value="Please select"/>

Figure 54: Loading/saving firmware updates and configurations using (T)FTP

To carry out the preferred action, start by selecting an action from the drop-down menu in the “Mode” line. The action can only be carried out when the server path specified does actually exist. Furthermore, any firewalls that have been installed must be configured in a way that allows (T)FTP communication.

The following actions can be selected individually:

- "Load config from server"** action: A configuration stored on the (T)FTP server is transmitted to the U 168 and can be activated immediately. The IP settings for the data and management interfaces on the device are not changed. The file "settings.xml" are written onto the U 168.
- "Save config to server"** action: The current configuration of the U 168 is written to the (T)FTP server. The configuration includes the following files:
  - "ip.xml" (IP settings for the data and management interfaces)
  - "settings.xml" (all other settings, e.g. IP receiver and modulator settings)
  - "user.xml" (user data)
- "Update firmware from server"** action: If you select this action, you must specify the preferred software version under *Version* (a 4-character maximum applies). Once the update is successful, the message "Firmware update OK. Please reboot to use the new firmware version" appears.
- "Load firmware from server"** action: If you select this action, you must specify the preferred software version under *Version* (a 4-character maximum applies). The software selected is written to the SD memory card, but will not be unpacked.
- "Unpack \*.up archive"** action: If you select this action, the update archive is unpacked and saved to the SD memory card (specify the version number).
- "Update firmware from SD card"** action: If you select this action, the specified update archive on the SD memory card is unpacked and programmed into the module (enter the version number).
- "Overwrite backup firmware"** action: The device software is saved in two partitions. The software saved in the first partition is used for operating the module, while the second partition is used to keep a backup copy ready for the event that the update process fails. As long as both partitions are different, the information "Backup differs" will be displayed in the menu "Active Alarm Table". The current software is copied to the backup partition when this action is carried out.

Once you have selected an action, you can add any information still missing from the remaining lines of the table:

- (T)FTP Server address: Address of the server
- Protocol: Activate the radio button "FTP" if you wish to use the more comprehensive FTP protocol. Activate the radio button "TFTP" if you wish to use the more basic TFTP protocol.
- FTP User name: This depends on the settings for the FTP server used (for astro-firmware.de e.g. "anonymous").
- FTP Password: This depends on the settings for the FTP server used (for astro-firmware.de e.g. "astro").
- Path: Path to the location where data are saved, or from where the data can be loaded. The path must be specified in relation to the root directory of the FTP server, and must always begin with a "/" and end with a "/" as well (enter without quotation marks).
- Version: Enter the version number of the software which you wish to download or save here.

**NOTE:** If the update is carried out using the TFTP protocol, then filling in the input fields "FTP User name" and "FTP Password" is not necessary.



## “System Log” menu

To have the system log displayed, click on “System log” in the menu at the left. The following overview will now appear:

**System Log Settings**

**Local logfile**

Log file filter:  Emergency  Alert  Critical  Error  Warning  Notice  Info  Debug

Debug log file:  on  off

Delete log files after: 90 days

**Syslog**

Syslog server: 0.0.0.0 0.0.0.0 0.0.0.0 0.0.0.0 0.0.0.0 0.0.0.0

Syslog filter:  Emergency  Alert  Critical  Error  Warning  Notice  Info  Debug

**SNMP traps**

SNMP trap receiver: 0.0.0.0 0.0.0.0 0.0.0.0 0.0.0.0 0.0.0.0 0.0.0.0

SNMP trap community: public

SNMP trap filter:  Emergency  Alert  Critical  Error  Warning  Notice  Info  Debug

**SNMP agent**

SNMP access:  on  off

SNMP GET/SET community: public

Access permission:  Read  Write  Read  Write  Read  Write  Read  Write  Read  Write

SNMP authentication failure trap:  on  off

Enforce community policy:

Note: Use empty fields for unused SNMP addresses or communities  
Note: To enforce community policy login as admin.

Submit Reset Form

**SNMP MIBs**

astromib

English manual: st156maine.pdf  
German manual: st156maing.pdf

**System Log**

Refresh  Check box to clear log on refresh

System log in CSV format: log.csv  
Debug log in CSV format: debug.csv  
Use right click and "save as" to save locally

number	time	uptime	user	source	severity	message
1	09 Jul 2014 11:20:09 UTC	0d 00h 02m 00s	system	0.0.0.0	notice	Fan good (9000)
0	09 Jul 2014 11:10:54 UTC	0d 00h 05m 47s	admin	192.168.1.196	info	1 user (evan)

Figure 55: System log

You can check or configure the following parameters individually:

### System log settings

**System Log Settings**

**Local logfile**

Log file filter:  Emergency  Alert  Critical  Error  Warning  Notice  Info  Debug

Debug log file:  on  off

Delete log files after: 90 days

**Syslog**

Syslog server: 0.0.0.0 0.0.0.0 0.0.0.0 0.0.0.0 0.0.0.0 0.0.0.0

Syslog filter:  Emergency  Alert  Critical  Error  Warning  Notice  Info  Debug

**SNMP traps**

SNMP trap receiver: 0.0.0.0 0.0.0.0 0.0.0.0 0.0.0.0 0.0.0.0 0.0.0.0

SNMP trap community: public

SNMP trap filter:  Emergency  Alert  Critical  Error  Warning  Notice  Info  Debug

**SNMP agent**

SNMP access:  on  off

SNMP GET/SET community: public

Access permission:  Read  Write  Read  Write  Read  Write  Read  Write  Read  Write

SNMP authentication failure trap:  on  off

Enforce community policy:

Note: Use empty fields for unused SNMP addresses or communities  
Note: To enforce community policy login as admin.

Submit Reset Form

Figure 56: Filter settings for the system log display

You can activate or deactivate filters for displaying the log entries here. To have messages from the corresponding category displayed, activate the checkbox allocated to the category.

**NOTE:** You can connect to higher-level management systems using the “Syslog” and “SNMP” parameters.

### Management Information Base (MIB)

The SNMP MIBs available are stored on the device and can be downloaded by using the download link below the table "System Log Settings".

### System log

#### System Log

Check box to clear log on refresh

System log in CSV format: [log.csv](#)  
 Debug log in CSV format: [debug.csv](#)  
 Use right click and "save as" to save locally.

number	time	uptime	user	source	severity	message
1	01 Jan 1970 00:14:05 UTC	0d 00h 14m 05s	user	192.168.1.26	info	Login
2	01 Jan 1970 00:14:00 UTC	0d 00h 14m 00s	admin	192.168.1.26	info	Logout
3	01 Jan 1970 00:12:41 UTC	0d 00h 12m 41s	admin	192.168.1.26	info	Login
4	01 Jan 1970 00:10:19 UTC	0d 00h 10m 19s	system	local	info	Login timeout
5	01 Jan 1970 00:01:41 UTC	0d 00h 01m 41s	admin	192.168.1.26	info	Login
6	01 Jan 1970 00:01:31 UTC	0d 00h 01m 31s	system	local	warning	Time is not synced
7	01 Jan 1970 00:00:32 UTC	0d 00h 00m 32s	system	local	critical	Fan fail (0)
8	01 Jan 1970 00:00:26 UTC	0d 00h 00m 26s	boot	local	info	Ready
9	01 Jan 1970 00:00:26 UTC	0d 00h 00m 26s	system	local	warning	Backup firmware differs!

Figure 57: Logfiles

Click on the "Refresh" button to update the system log display. The entries in the system log are sorted chronologically according to the time at which the event occurred.

If you do not wish for the existing entries to be displayed after a refresh, activate the checkbox "Check box to clear log on refresh". Once the checkbox has been activated, after a refresh, the process of deleting the old log entries is listed as the first entry (specified the user account and the current time upon deletion).

You can also download the following logfiles:

- System log (CSV format)
- Debug log (CSV format)

### Downloading log files

#### Download Log Files

Logfile	Last modified at	Size
<a href="#">/0216da.csv</a>	09.07.2014 11:20:12	2.20 kiB

Figure 58: Downloading log files

A maximum of 2,500 lines is displayed in the "Log files" table. The complete log file can be downloaded from the "Download Log Files" table by clicking on the file name XX.csv.

## “Alarm severities” menu

You can change the alarm settings for diverse parameters or deactivate the alarm display for a parameter, when preferred. To do so, click on the item “Alarm Severities” in the menu at the left. A set of tables for different parameter groups then appears:

### Status of power supply, temperature, fan

Code	Message	emergency	alert	critical	error	warning	notice	info	debug	off
0x1000002	Temp 1 fail (%.1f)	<input type="radio"/>	<input type="radio"/>	<input checked="" type="radio"/>	<input type="radio"/>	<input type="radio"/>	<input type="radio"/>	<input type="radio"/>	<input type="radio"/>	<input type="radio"/>
0x1000002	Temp 1 good (%.1f)	<input type="radio"/>	<input type="radio"/>	<input type="radio"/>	<input type="radio"/>	<input type="radio"/>	<input checked="" type="radio"/>	<input type="radio"/>	<input type="radio"/>	<input type="radio"/>
0x1000003	Temp 2 fail (%.1f)	<input type="radio"/>	<input type="radio"/>	<input checked="" type="radio"/>	<input type="radio"/>	<input type="radio"/>	<input type="radio"/>	<input type="radio"/>	<input type="radio"/>	<input type="radio"/>
0x1000003	Temp 2 good (%.1f)	<input type="radio"/>	<input type="radio"/>	<input type="radio"/>	<input type="radio"/>	<input type="radio"/>	<input checked="" type="radio"/>	<input type="radio"/>	<input type="radio"/>	<input type="radio"/>
0x1000004	Temp 3 fail (%.1f)	<input type="radio"/>	<input type="radio"/>	<input checked="" type="radio"/>	<input type="radio"/>	<input type="radio"/>	<input type="radio"/>	<input type="radio"/>	<input type="radio"/>	<input type="radio"/>
0x1000004	Temp 3 good (%.1f)	<input type="radio"/>	<input type="radio"/>	<input type="radio"/>	<input type="radio"/>	<input type="radio"/>	<input checked="" type="radio"/>	<input type="radio"/>	<input type="radio"/>	<input type="radio"/>
0x1000005	Temp 4 fail (%.1f)	<input type="radio"/>	<input type="radio"/>	<input checked="" type="radio"/>	<input type="radio"/>	<input type="radio"/>	<input type="radio"/>	<input type="radio"/>	<input type="radio"/>	<input type="radio"/>
0x1000005	Temp 4 good (%.1f)	<input type="radio"/>	<input type="radio"/>	<input type="radio"/>	<input type="radio"/>	<input type="radio"/>	<input checked="" type="radio"/>	<input type="radio"/>	<input type="radio"/>	<input type="radio"/>
0x1000006	Fan fail (0)	<input type="radio"/>	<input type="radio"/>	<input checked="" type="radio"/>	<input type="radio"/>	<input type="radio"/>	<input type="radio"/>	<input type="radio"/>	<input type="radio"/>	<input type="radio"/>
0x1000006	Fan good (%.0f)	<input type="radio"/>	<input type="radio"/>	<input type="radio"/>	<input type="radio"/>	<input type="radio"/>	<input checked="" type="radio"/>	<input type="radio"/>	<input type="radio"/>	<input type="radio"/>
0x1000007	Supp 1.2 fail (%.2f)	<input type="radio"/>	<input type="radio"/>	<input checked="" type="radio"/>	<input type="radio"/>	<input type="radio"/>	<input type="radio"/>	<input type="radio"/>	<input type="radio"/>	<input type="radio"/>
0x1000007	Supp 1.2 good (%.2f)	<input type="radio"/>	<input type="radio"/>	<input type="radio"/>	<input type="radio"/>	<input type="radio"/>	<input checked="" type="radio"/>	<input type="radio"/>	<input type="radio"/>	<input type="radio"/>
0x1000008	Supp 1.5 fail (%.2f)	<input type="radio"/>	<input type="radio"/>	<input checked="" type="radio"/>	<input type="radio"/>	<input type="radio"/>	<input type="radio"/>	<input type="radio"/>	<input type="radio"/>	<input type="radio"/>
0x1000008	Supp 1.5 good (%.2f)	<input type="radio"/>	<input type="radio"/>	<input type="radio"/>	<input type="radio"/>	<input type="radio"/>	<input checked="" type="radio"/>	<input type="radio"/>	<input type="radio"/>	<input type="radio"/>
0x1000009	Supp 1.8 fail (%.2f)	<input type="radio"/>	<input type="radio"/>	<input checked="" type="radio"/>	<input type="radio"/>	<input type="radio"/>	<input type="radio"/>	<input type="radio"/>	<input type="radio"/>	<input type="radio"/>
0x1000009	Supp 1.8 good (%.2f)	<input type="radio"/>	<input type="radio"/>	<input type="radio"/>	<input type="radio"/>	<input type="radio"/>	<input checked="" type="radio"/>	<input type="radio"/>	<input type="radio"/>	<input type="radio"/>
0x100000a	Supp 2.5 fail (%.2f)	<input type="radio"/>	<input type="radio"/>	<input checked="" type="radio"/>	<input type="radio"/>	<input type="radio"/>	<input type="radio"/>	<input type="radio"/>	<input type="radio"/>	<input type="radio"/>
0x100000a	Supp 2.5 good (%.2f)	<input type="radio"/>	<input type="radio"/>	<input type="radio"/>	<input type="radio"/>	<input type="radio"/>	<input checked="" type="radio"/>	<input type="radio"/>	<input type="radio"/>	<input type="radio"/>
0x100000b	Supp 3.3 fail (%.2f)	<input type="radio"/>	<input type="radio"/>	<input checked="" type="radio"/>	<input type="radio"/>	<input type="radio"/>	<input type="radio"/>	<input type="radio"/>	<input type="radio"/>	<input type="radio"/>
0x100000b	Supp 3.3 good (%.2f)	<input type="radio"/>	<input type="radio"/>	<input type="radio"/>	<input type="radio"/>	<input type="radio"/>	<input checked="" type="radio"/>	<input type="radio"/>	<input type="radio"/>	<input type="radio"/>
0x1000010	Supp 5.2 fail (%.2f)	<input type="radio"/>	<input type="radio"/>	<input checked="" type="radio"/>	<input type="radio"/>	<input type="radio"/>	<input type="radio"/>	<input type="radio"/>	<input type="radio"/>	<input type="radio"/>

Figure 59: Alarm Severities

The preset options for the alarm messages are identified by a green frame. Retaining these settings is recommended.

## “Active alarms” menu

To have the “Active Alarm” table displayed, click on the corresponding item in the menu at the left. The following table now appears:

### Active Alarm Table

number	time	uptime	user	source	severity	message	TSID	SID	alias
--------	------	--------	------	--------	----------	---------	------	-----	-------

ASTRO Strobel Kommunikationssysteme GmbH

*Figure 60: Active alarm table*

The table provides information about error messages currently active. The “Message” column shows the error message in plain text.

**NOTE:** You can also access the “Active Alarm Table” by clicking the red point in the status line in the upper section of the user interface.

To retrieve data transmission statistics for the U 168, click on the “Statistics” item in the menu at the left. All statistics relevant to the operation of the device and which can be used for analysis are displayed here. The following tables are displayed individually:

**Ethernet bandwidth**

Ethernet bandwidth

Property	Management A (eth0) 1G full	Management B (eth1) 1G full	Data A (eth2) 1G full	Data B (eth3) 1G full
Transmit	0.0 Mbit/s	0.0 Mbit/s	57.5 Mbit/s	0.0 Mbit/s
Receive	0.0 Mbit/s	0.0 Mbit/s	0.0 Mbit/s	0.0 Mbit/s

Figure 61: Ethernet bandwidth

The transmission rates for sending (transmit) and reception (receive) are specified for the respective interfaces Management A, Management B, Data A and Data B.

**Ethernet frames**

Property	Data A (eth2) 1G	Data B (eth3) 1G
Total frames sent by host	2	0
Total frames sent to host	3	54
Total exception frames sent to host	19	2
Total errored frames received	0	0
Total frames discarded by deencapsulator	0	0
Total frames discarded because of lack of buffers	0	0
Total transmit frames generated from IP TX 1 / per sec.	107441 / 1260	0 / 0
Total transmit frames generated from IP TX 2 / per sec.	120496 / 1417	0 / 0
Total transmit frames generated from IP TX 3 / per sec.	106750 / 1260	0 / 0
Total transmit frames generated from IP TX 4 / per sec.	106461 / 1260	0 / 0

Figure 62: Ethernet frames

The following parameters are displayed for the interfaces Data A and Data B, in this order:

- The number of IP frames transmitted to the processor is specified in the first three lines of the table.
- Number of defective frames.
- Number of frames which could not be allocated.
- Number of frames which could not be allocated due to exceeding the total buffer depth.
- The number of frames transmitted per transport stream in total or per second is displayed in the following lines for each IP transmitter.

**Ethernet TX**

Property	Value
Minimum FEC Freelist	220
Maximum output queue depth	255

*Figure 63: Ethernet TX*

In reference to forward error correction, the smallest number of free FEC buffers measured at all is displayed in the first line.  
 The total number of FEC buffers is displayed in the second line.

To have the network settings displayed, click on “Network” in the menu at the left. The following overview will now appear:

**Interface statistics**

Interface	Statistics
eth3	IPv4: 172.25.0.150, Broadcast: 172.25.255.255, Netmask: 255.255.0.0
	UP BROADCAST RUNNING MULTICAST MTU: 1500, Metric: 0
	Rx - Packets: 0, Bytes: 0, Tx - Packets: 0, Bytes: 0
eth2	IPv4: 172.24.0.150, Broadcast: 172.24.255.255, Netmask: 255.255.0.0
	UP BROADCAST RUNNING MULTICAST MTU: 1500, Metric: 0
	Rx - Packets: 0, Bytes: 0, Tx - Packets: 0, Bytes: 0
eth1	IPv4: 192.168.5.150, Broadcast: 192.168.5.255, Netmask: 255.255.255.0
	UP BROADCAST RUNNING MULTICAST MTU: 1500, Metric: 0
	Rx - Packets: 30, Bytes: 2340, Tx - Packets: 0, Bytes: 0
eth0	IPv4: 192.168.1.150, Broadcast: 192.168.1.255, Netmask: 255.255.255.0
	UP BROADCAST RUNNING MULTICAST MTU: 1500, Metric: 0
	Rx - Packets: 3414, Bytes: 314554, Tx - Packets: 3674, Bytes: 3042143
lo0	IPv4: 127.0.0.1, Broadcast: 127.0.0.1, Netmask: 255.0.0.0
	UP LOOPBACK RUNNING MULTICAST MTU: 16384, Metric: 0
	Rx - Packets: 387, Bytes: 32207, Tx - Packets: 387, Bytes: 32207

**Routing tables**

Destination	Gateway	Mask	Flags	Interface	Genmask
0.0.0.0	192.168.1.100	0.0.0.0	UG	eth0	
127.0.0.0	127.0.0.1	255.0.0.0	UG	lo0	

Figure 64: Network settings

The detailed interface statistic properties which are displayed are for information purposes only, and are used to describe the network. They could be useful for customer service in the event of a fault.

## "Devices" menu

To have an overview of the local data memory in the device displayed, click on the item "Devices" in the menu at the left. Among other things, the total memory capacity, the capacity of the unused memory, and the files saved are displayed.

## Troubleshooting

If the device is not functioning correctly, please perform the following checks:

- Check whether the device is connected to the required grid voltage (230 V~, 50 Hz for the U 100 base unit, and 48 V for the U 100-48 base unit).
- Check whether the signal cable is connected correctly, and that there are no breaks or short circuits in the connectors.

If the problem cannot be resolved, please contact the ASTRO customer service.

## Maintenance and repair

The device must not be opened other than for repair purposes. Repairs may only be carried out at the factory or at workshops, or by persons, authorised by ASTRO Strobel GmbH.

Read carefully: EN 60728-11 Safety requirements: No service work during thunderstorms.

**NOTE:** *In the event of repairs, the DIN VDE regulations 0701 - 0702, where applicable, must be observed, and priority must be given to the relevant data requirements in DIN EN 60950-1. You must disconnect the power plug before opening the device!*

## Service tasks

The following tasks, which involve the removal of screw connections, can be performed by appropriately instructed service personnel: Removal and installation of signal converters (e.g. U 164) and power modules, even when the U 100 is operating.

### Replacing power modules

After removing the screws from the cover of the power module chamber (ASTRO logo), the power modules can be pulled forwards by hand using the mounting tab. When installing power modules, do not touch the fan or fan grille and only use the mounting tab affixed to the power module.

When the tasks are complete, the cover of the power module chamber must be replaced. Continuous operation of the device is not permitted without this cover.

**ATTENTION:** *Never reach into the power module division of the U 100-230 base unit, or insert objects into it.*

**NOTE:** *The U 100-230 base unit must only be operated with the original power module(s)!*

### Replacing converter modules

Converter modules can be pulled out to the front after removing the safety screw in the front covers (see section "Connecting and installing the module")



Type		U 164	
Order number		380 164	
EAN-Code		4026187170769	
<b>Interfaces</b>			
Management		2 x 100 Base-T Ethernet (RJ 45)	
Data		2 x 1000 Base-T Ethernet (RJ 45)	
Protocols		IEEE802.3 Ethernet, RTP, ARP, IPv4, TCP/UDP, HTTP, SNMP, IGMPv3	
<b>Transportstream Encapsulation</b>			
Protocols		UDP, UDP / RTP, 1-7 packets, FEC	
Packet length	Bytes	188 / 204	
<b>DVB-C demodulator</b>			
Input data rate	[Mbaud]	0,5 - 7	
Modulation modes (accord. DVB-standard)		QPSK, QAM16, QAM32, QAM64, QAM128, QAM256	
<b>DVB-T demodulator / DVB-T2 demodulator</b>			
Modulation		DVB-T: 4-, 16-, 64-QAM	DVB-T2: 4-, 16-, 64-, 256-QAM
Guardinterval		DVB-T: 1/4; 1/8; 1/16; 1/32	DVB-T2: 1/4; 5/32; 1/8; 5/64; 1/16; 1/32; 1/64; 1/128
FEC		DVB-T: 1/2; 2/3; 3/4; 5/6; 7/8	DVB-T2: 1/2; 3/5; 2/3; 3/4; 4/5; 5/6
FFT-Mode		DVB-T: 2k, 8k	DVB-T2: 1k, 2k, 4k, 8k, 16k, 32k
Bandwidth	[MHz]	DVB-T: 6; 7; 8	DVB-T2: 5; 6; 7; 8
Remote voltage supply		5V, typ. 100mA, switchable	
<b>CI interfaces</b>			
CI slots		4 x (front access)	
Supported modules	excerpt (others on request)	Alphacrypt, Aston Conax, Dreamcrypt, Entavio CAM, GkWare BISS CAM, Homecast CAM, ICECrypt, Ideto Access, Kid CAM, Mascom Cryptoworks, Matrix CAM, Mediaguard Canal Digitaal, Nagravision, Oasis CAM, PCMCIA CAM, Premiere, Worldcam, TechniCam Beta2, Technicrypt, TPS, Reality CAM, SMIT, Universal CAM, Viaccess, Videoguard CAM	
Connectors		4 x PCMCIA	
<b>RF inputs</b>			
Connectors	Ω	75, 4 x F-jack	
<b>Common data</b>			
when mounted in base unit U 100-48:			
Current consumption at 48 V	mA	680	
Power consumption at 48 V	W	28 per module	
Input voltage	V	- 48	
when mounted in base unit U 100-230:			
Input voltage	VAC	100 - 240 (50 / 60 Hz)	
Input power consumption	W / VA	one power supply, three modules: 121,2 / 144; two power supplies, three modules: 144,1 / 158	
Dimensions		1 HU, 19 inch	
Ambient temperature	°C	0 ... +45	

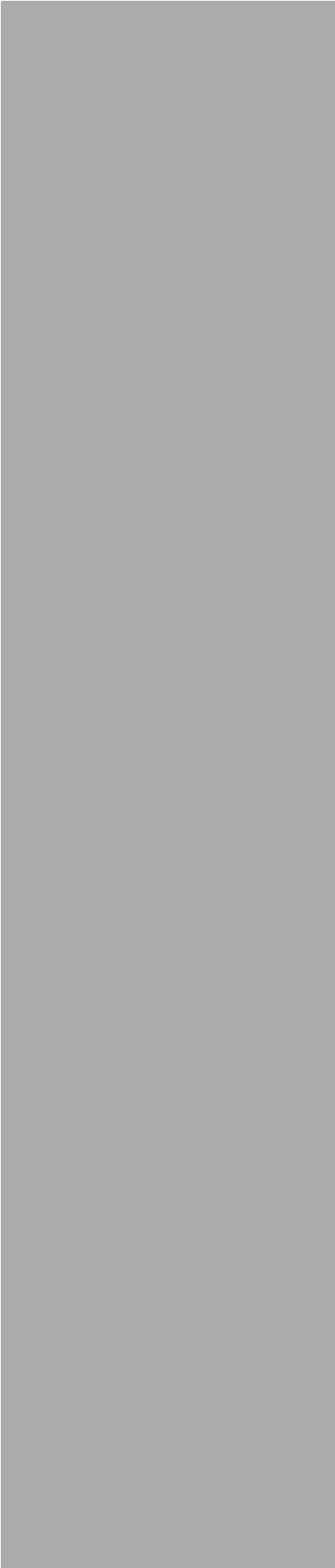

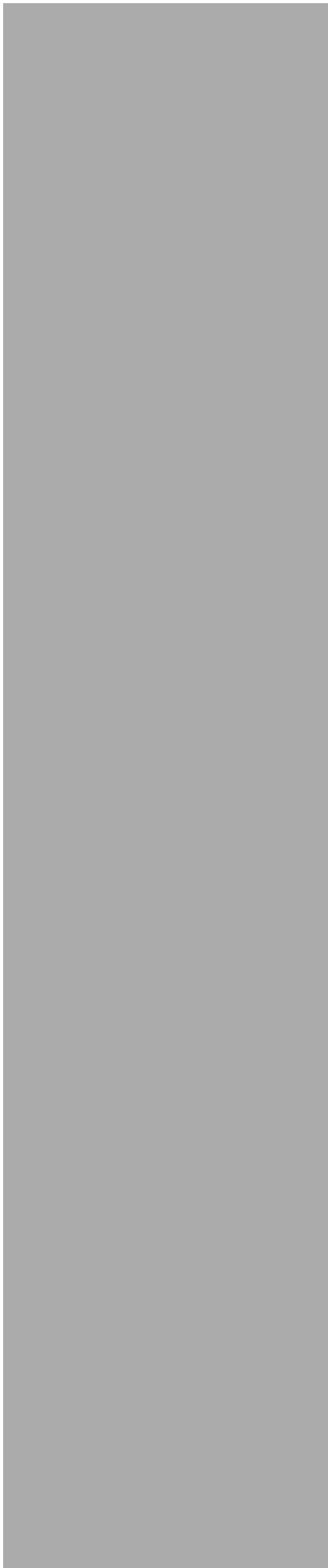



## ASTRO Strobel Kommunikationssysteme GmbH

© 2014 ASTRO

Subject to change.

Change management and copyright:

This document contains information protected by copyright. It is prohibited to photocopy, duplicate, translate or store on data storage media this document, either partially or in full, without prior agreement of the ASTRO company.

These operating instructions have been written by:

ASTRO Strobel Kommunikationssysteme GmbH

Olefant 1-3, D-51427 Bergisch Gladbach (Bensberg)

Tel.: 02204/405-0, Fax: 02204/405-10

eMail: [kontakt@astro.kom.de](mailto:kontakt@astro.kom.de)

Internet: [www.astro-kom.de](http://www.astro-kom.de)

All the information contained in this document has been checked in good faith.

The ASTRO company cannot be held liable for any damage or injury arising in connection with the use of these operating instructions.